

Preface

Thank you for using ALPHA6000E, ALPHA6000M series inverters.

This series of inverters adopt the most advanced current vector control technology that features low speed rated torque output and ultra-quiet stable running. They are characterized by diverse control modes, up to 36 perfect protection and alarm functions, on-line monitoring and on-line adjustment of a variety of parameters, built-in RS-485 communication interface, flexible operation, and thus satisfy various needs of users.





This series of inverters apply to most motor drive applications, including paper making, textile, food, cement, printing and dyeing, plastic machinery, and other industries. As speed controllers, this series of inverters possesses good adaptability of load, running stability, high precision and good reliability. They can improve the power factor and efficiency, and be used as a power-efficient application.

If you have some problems that can't be solved in operation, please contact the nearest local agents, or contact our company directly.

To ensure the perfect use of this product and the safety of users, please read the user manual carefully before the operation of inverter and keep the manual in proper place for future reference.

The information contained in this manual is subject to change without notice.

Before mounting, commissioning and using the inverter, it is strongly suggested that you must read the safety rules and warnings listed in this book and cautions marked on the inverter to ensure your safety and extending the service life of this equipment. When in operation, pay attention to the situation of load and all notes that related to safety.

	Danger!
	<ul style="list-style-type: none"> ◆ This equipment contains dangerous voltage. Operations not accordant with this manual might cause life risk and human injury. Only qualified personnel shall wire the drive.
	<ul style="list-style-type: none"> ◆ Please cut off the power before wiring and inspecting. It is not permissible to touch PCB or interior components before battery control lamp goes off or until 5 minutes after the power has been removed. It is necessary to use meters to confirm the charging capacitor has discharged off. Otherwise, a risk of electric shock may happen.
	<ul style="list-style-type: none"> ◆ Don't connect AC power source to the output terminals U, V, W of the inverter. When using the inverter, the earthing terminal of the inverter must be grounded correctly and reliably according to IEC electrical safety regulation.
	Warning!
	<ul style="list-style-type: none"> ◆ Unauthorized change of inner wiring and using accessories sold or recommended by unqualified manufacturer may cause fire, electric shock and injury.
	<ul style="list-style-type: none"> ◆ Since body static electricity may cause serious damage to MOS field-effect transistor and other sensitive elements. Please don't touch the interior devices, such as PCB, IGBT module etc. before any measure is taken to prevent static electricity.
	Caution!
	<ul style="list-style-type: none"> ◆ Keep all marks and labels are clear to read. Replace the lost or worn mark at any moment. ◆ Please keep the user manual near the inverter that can be reached easily and give this manual to the users who use the product.

All rights reserved. The contents in this document are subject to change without notice. If you have any questions and problems about the use of our products, please contact our agents or us. Any suggestions for improvement are welcome.

Contents

Preface.....	1
Chapter 1 Purchase Inspection	5
1.1 Unpacking Inspection	5
1.2 Naming Rule.....	5
1.3 Nameplate of Inverter	6
Chapter 2 Installation and Wiring	7
2.1 Mounting Place Requirements and Management.....	7
2.1.1 Installation Location	7
2.1.2 Ambient Temperature.....	8
2.1.3 Preventive Measures	8
2.2 Installation Direction and Space	8
2.3 Main Circuit Wiring	9
2.3.1 Main parts of product.....	9
2.3.2 Schematic diagram of connection and disassembly main circuit terminals	11
2.3.3 The Main Circuit Terminals Arrangement and Wiring.....	13
2.3.4 Main Circuit Wiring Operation.....	14
2.4 Control Circuit Connection.....	15
2.4.1 Function of Control Circuit Terminals.....	15
2.4.2 Wiring of Control Circuit Terminals	19
2.5 Wiring of Inverter for Basic Operation.....	23
2.6 Wiring Attentions	23
Chapter 3 Operation	25
3.1 Function and Operation of Keypad.....	25
3.1.1 Keypad Layout	26
3.1.2 Description of Button Function	26
3.1.3 Description of LED Digital Tube and Indicators	28
3.1.4 Operation Method of Keypad	28
3.2 Run Command Mode Select.....	30
3.3 Trial Operation	30
3.3.1 Operation Mode of Inverter	30
3.3.2 Operation of Initial Power On.....	31
3.3.3 First Test Run Operation.....	33
Chapter 4 Parameter Index	34
Chapter 5 Detailed Function Introductions.....	79
5.1 Basic Function (Group P0)	79
5.2 Start/Stop Control (Group P1)	85

Contents

5.3	Auxiliary Operation (Group P2)	93
5.4	I/O Terminal Ctrl (Group P3)	99
5.5	Analog and Pulse Function (Group P4)	116
5.6	PLC Operating (Group P5)	120
5.8	PID Control (Group P7)	125
5.9	Vector Control Mode (Group P8)	131
5.10	V/F Control (Group P9)	135
5.11	Motor Parameters (Group PA)	141
5.12	MODBUS Communication (Group Pb)	144
5.13	Display Control (Group PC)	146
5.14	Protection and Fault Parameters (Group Pd)	150
5.15	Running History Record (Group PE)	156
5.16	Protection of Parameters (Group PF)	158
Chapter 6 Troubleshooting		162
6.1	Troubleshooting	162
6.2	Warning Display and Explanation	168
6.3	Motor's Faults and Corrective Measure	169
Chapter 7 Peripheral Equipment		172
7.1	Peripheral Equipment Connection Diagrams	172
7.2	Function of Peripheral Equipment	174
7.2.1	AC Input Reactor	174
7.2.2	Braking Unit and Braking resistor	174
7.2.4	Leakage Protector	175
7.2.5	Capacitor Box	176
Chapter 8 Maintenance		177
8.1	Inspection and Maintenance	177
8.1.1	Daily Inspection	177
8.1.2	Regular Maintenance	178
8.1.3	Regularly-replaced Elements	180
8.2	Storage and Protection	180
Appendix 1 External Dimension and Installation Dimension		181
Appendix 2 Technical Specifications		183
Appendix 3 Use of MODBUS Communication		185
Appendix 4 Keypad and tray(trepanning) Installation Dimension		198
Appendix 5 Inverter Warranty Card		199

Chapter 1 Purchase Inspection

1.1 Unpacking Inspection

All inverters have passed the strict tests before delivery. After unpacking, please check if the product is damaged by careless transport, whether the product specification and model are complied with the order, and if it has a quality check passed mark. If there is any problem, please contact the supplier.

1.2 Naming Rule

The naming rule of the product is as following

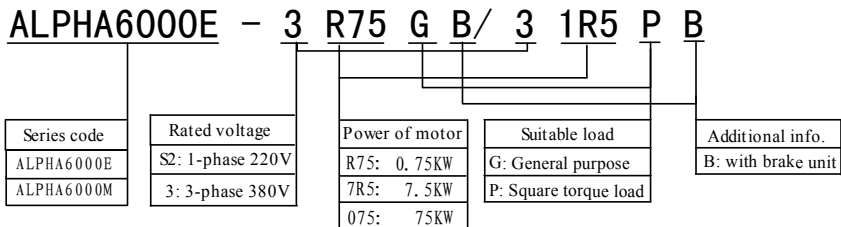

Fig. 1-1 Model code

Bottom-level modules of ALPHA6000E and ALPHA6000M series inverters are high performance motor control modules, which contain three control modes, i.e. V/F, sensor-less vector control (SVC), V/F separation.

Notes: ALPHA6000M-S2R4GB and ALPHA6000M-S2R75GB have no SVC mode.

1.3 Nameplate of Inverter

On the lower right side of inverter, there is a nameplate, which marks the model and rated value of inverter. Take a model of 6000E as example (ALPHA6000M is similar):

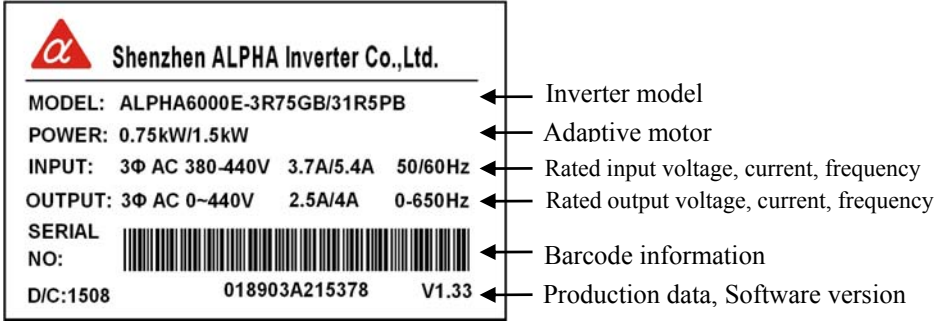

Fig. 1-2 Nameplate of Inverter

Chapter 2 Installation and Wiring

2.1 Mounting Place Requirements and Management



Attention

·Don't carry the inverter by its cover. The cover cannot support the weight of the inverter and the inverter may drop.

·Please install the inverter on a strong support, failing which the inverter may fall off.

·Don't install the inverter in places where water pipes may leak onto it.

·Don't allow screws, washers and other metal foreign matters to fall inside the inverter, otherwise there is a danger of fire or damage.

·Don't operate the inverter if parts are not complete, otherwise there is a danger of fire or human injury.

·Don't install the inverter under direct sunshine; otherwise, it may be damaged.

·Don't short circuit PB, + and -, otherwise there is a danger of fire or the inverter may be damaged.

·Cable lugs must be connected to main terminals firmly.

·Don't apply supply voltage (AC 220V) to control terminals except terminals TA, TB, TC.

Please mount the inverter as following instructions and maintain appropriate conditions

2.1.1 Installation Location

The installation location should meet the following conditions:

- ◆ Good indoor ventilation
- ◆ Ambient temperature: $-10\text{ }^{\circ}\text{C} \sim 40\text{ }^{\circ}\text{C}$. If the temperature is higher than $40\text{ }^{\circ}\text{C}$, forced ventilation or derating use is required.
- ◆ Humidity should be lower than 95%, no condensing and rain water drops.
- ◆ Do not mount the inverter on the timber or other combustible matters.
- ◆ Avoid direct sunlight.
- ◆ It is strictly prohibited to install the inverters in places where have flammable, explosive, corrosive gases or liquids;

- ◆ Mount in the location free of dust, metal powder, corrosive gas or combustible gas.
- ◆ The installation foundation should be solid and free of vibration.
- ◆ No electromagnetic interference, away from source of interference.
- ◆ Derating use must be considered when the inverter is installed at high altitude greater than 1000 m. This is because the cooling effect of inverter is deteriorated because of the thin air. Derating 6% per 1000 m above 1000m altitude.

2.1.2 Ambient Temperature

In order to enhance operating reliability of the inverter, be sure where the inverter mounted has a good ventilation; when the inverter is used in a closed case, cooling fans or an air-conditioning must be installed to keep the ambient temperature below 40°C

2.1.3 Preventive Measures

During installing, please set a shield to prevent metal debris falling into it, and remove the shield after installing.

Please remove the protection cover board when the ambient temperature is over 40° C or the internal temperature is too high due to other reasons. Otherwise the inverter should be derated. After removing the protection cover, pay attention to avoid small parts falling into the inverter.

2.2 Installation Direction and Space

Inverters of this series are all equipped fans for forced cooling. In order to be an effective cooling cycle, the inverter must be mounted in the vertical direction, up, down, left and right away from adjacent articles or baffle (wall) maintain adequate space, as Fig. 2-1, 2-2:

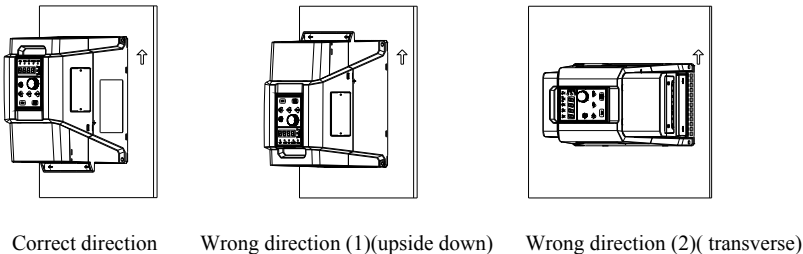

Fig. 2-1 Installation Direction Requirement

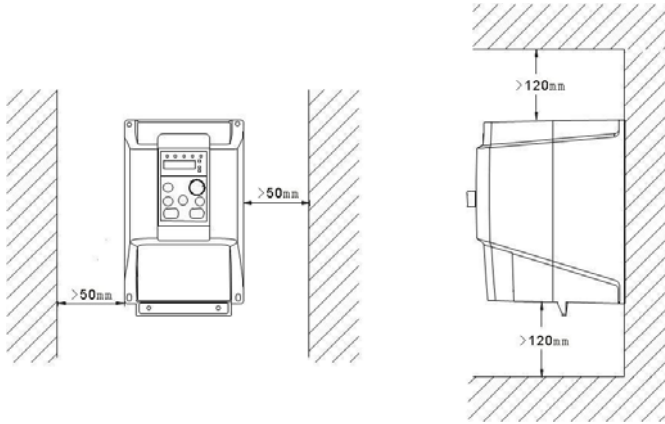

Fig. 2-2 Installation Direction and Space

2.3 Main Circuit Wiring

2.3.1 Main parts of product

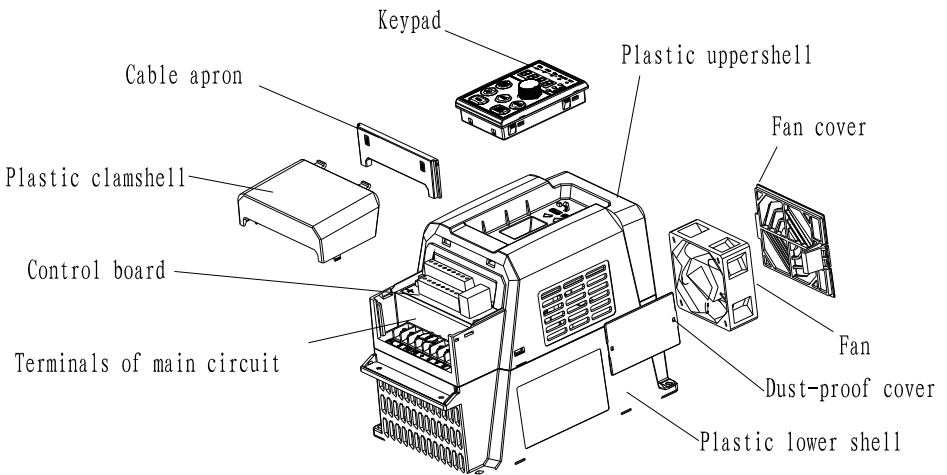
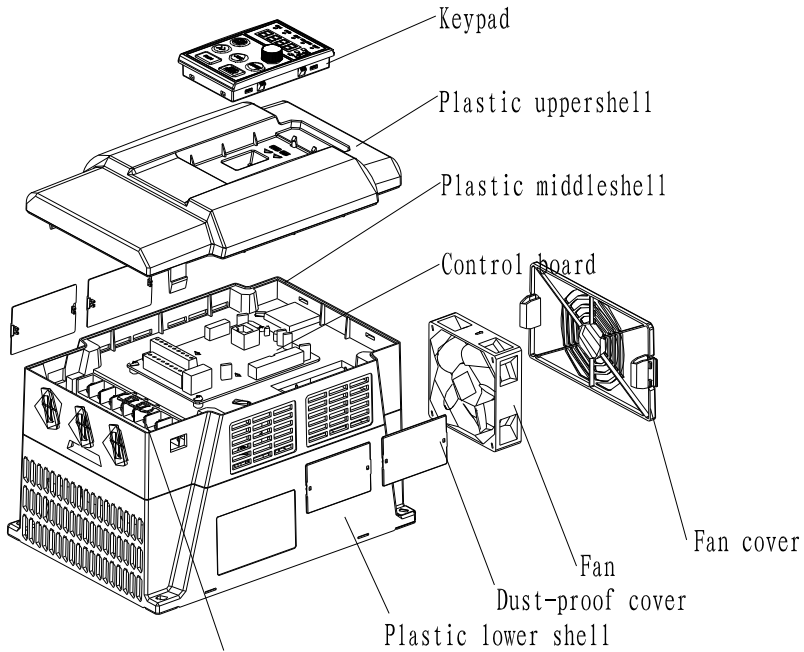

Fig. 2-3 Main parts of 4kW and below



Terminals of main circuit
Fig. 2-4 Main parts of 5.5kW-7.5kW

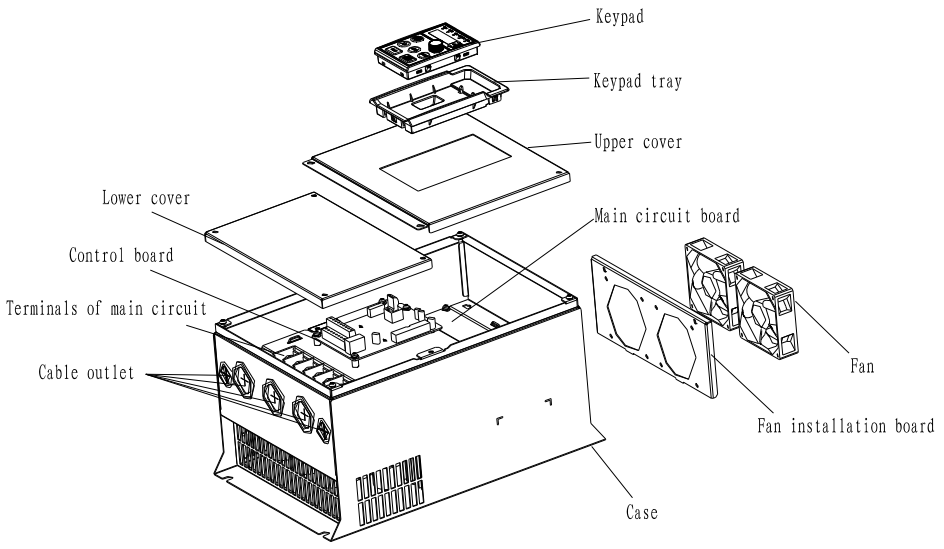

Fig. 2-5 Main parts of 11kW-160kW

2.3.2 Schematic diagram of connection and disassembly main circuit terminals

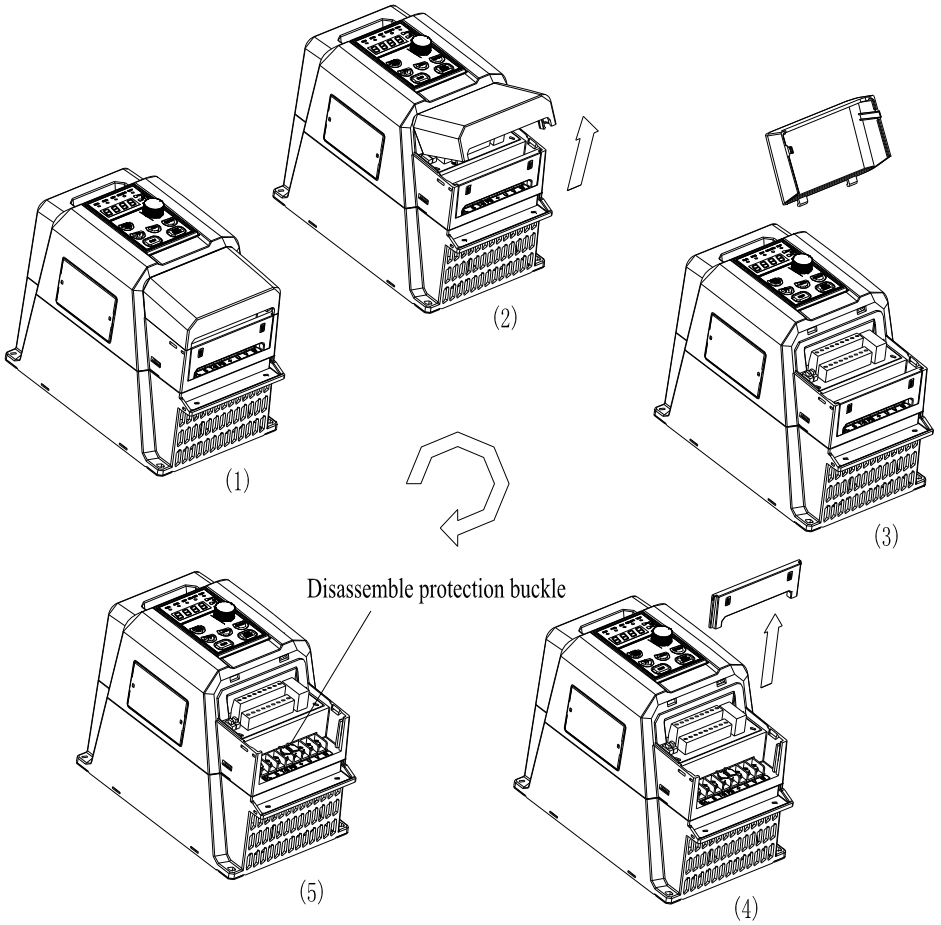

Fig. 2-6 Disassembly schematic diagram of 4kW and below

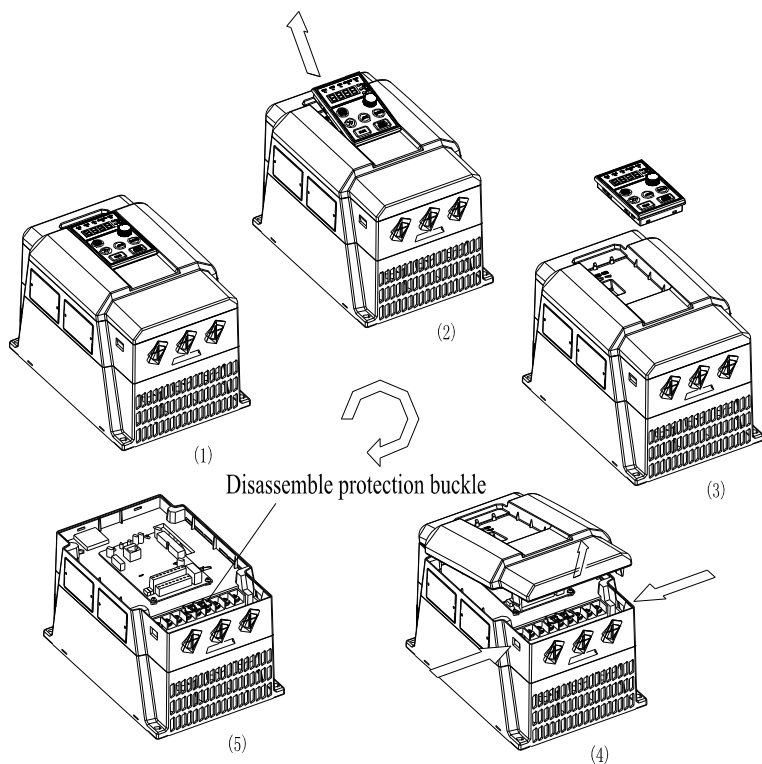

Fig. 2-7 Disassembly schematic diagram of 5.5kW-7.5kW

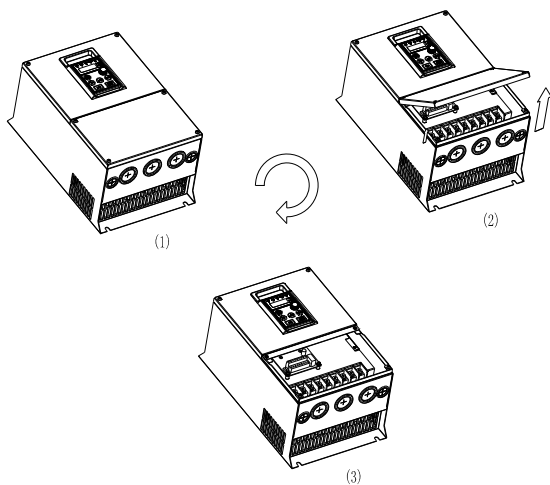

Fig. 2-8 Disassembly schematic diagram of 11kW-160kW

2.3.3 The Main Circuit Terminals Arrangement and Wiring

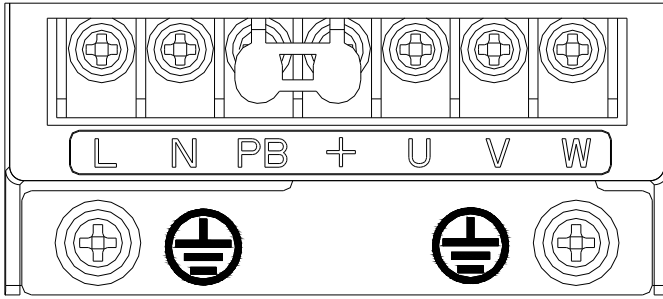

Fig. 2-9 Wiring of terminals of main circuit of 1PH 220V 0.4&0.75kW

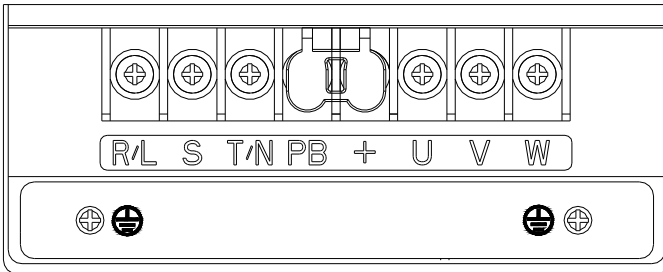

Fig. 2-10 Wiring of terminals of main circuit of 1PH 220V 1.5&2.2kW 3PH 380V 0.75-2.2kW

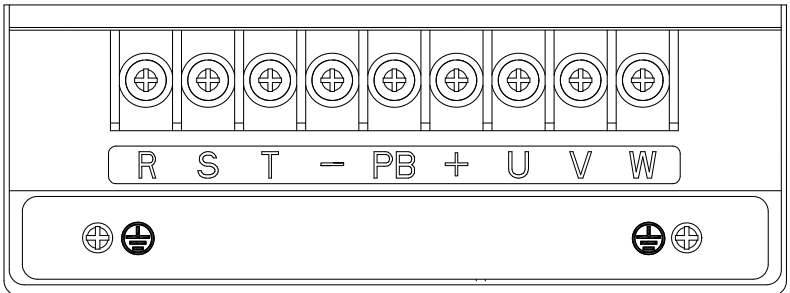

Fig. 2-11 Wiring of terminals of main circuit of 3PH 380V 4-15kW

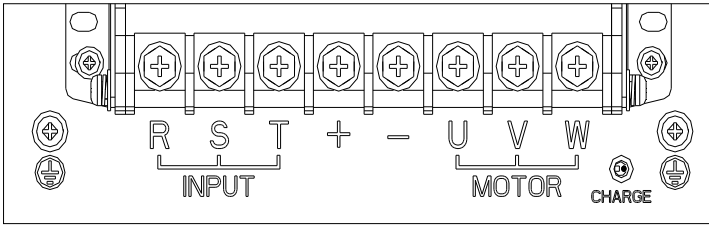

Fig. 2-12 Wiring of terminals of main circuit of 3PH 380V 18.5-30kW

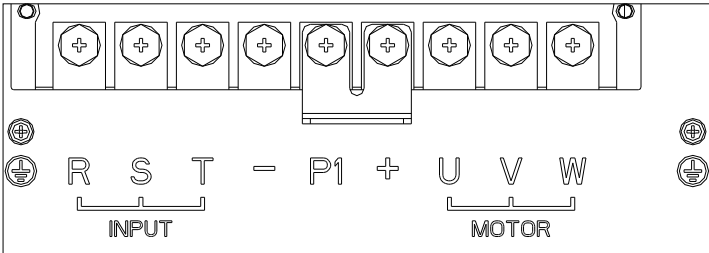

Fig. 2-13 Wiring of terminals of main circuit of 3PH 380V 37-160kW

Table 2-1 Description of terminals of main circuit

Terminal symbol	Terminal name and function
L, N / R, S, T	Single-phase AC 220V input terminals or Three-phase AC 380V input terminals
+, PB	Terminals for an external braking resistor
-	DC negative bus output terminal
U, V, W	Three-phase AC output terminals
PE	Protective earth terminals for input power or earthing terminals for motor cable shield and braking resistor cable shield.

2.3.4 Main Circuit Wiring Operation

Do not mistakenly connect the input power cable to the output terminal; otherwise the components in the inverter will be damaged. Output terminals are prohibited to be grounded. The lines should not be collided with the enclosure, or short connected; otherwise the inverter will be damaged.

Earth terminal PE must be grounded. 380V class grounding resistance should be 10Ω or less. The earth wire should never share with electric welder or power equipment. The earth wire should be of conductor diameter specified in the technical standard for electrical equipment, and should be as close to the ground point as possible. On occasions using more than two inverters at the same time, please do not form the earth wire into ring circuit. Proper grounding method and incorrect grounding method are shown in Fig. 2-14.

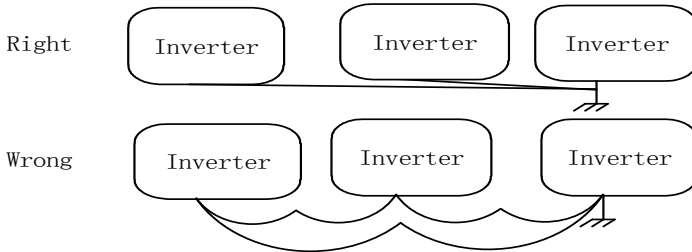

Fig. 2-14 Earthing Connection Method

Notes: The neutral point of motor using Y connection can't be connected to earth. Since the inverter output PWM wave, if a capacitor for improving power factor or a lightning varistor is installed on the output side, which would cause tripping or damage to parts, be sure to remove it.

If a contactor or other on-off part is installed between the output and the motor, be sure the on-off operation is done when the inverter has no output, otherwise the inverter would be damaged.

2.4 Control Circuit Connection

2.4.1 Function of Control Circuit Terminals

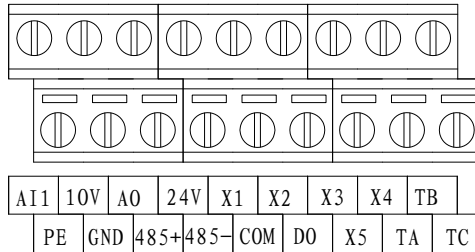

Fig. 2-15 Terminal arrangement of S2R4GB~S2R75GB

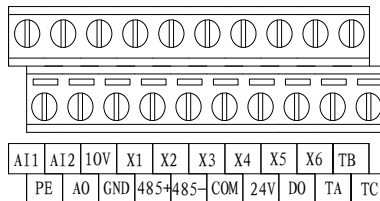

Fig. 2-16 Terminal arrangement of S21R5GB~S22R2GB, 3R75GB/31R5PB and above

In order to reduce interference and attenuation of control signal, the length of control cables should be limited in 50m and away from power cables for more than 30cm. Avoid control wire and power wire being parallel. Try to use STP (Shielded Twisted Pair) to connect analog input and output signal.

Table 2-2 Function of control circuit terminals

Category	Terminal label	Name	Description of terminal function	Specification
Analog input	AI1	Analog input 1	Receive voltage/current input. Voltage or current are selected by DIP switch SW3. Voltage input mode is the default mode. The range is shown in instructions in function code P4.01 ~ P4.05.	Input voltage range: 0~10V (input resistance: 30kΩ) Input current range: 0~20mA (input resistance: 250Ω) Reference ground: GND
	AI2	Analog input 2	Receive voltage input. The range is shown in instructions in function code P4.06~P4.10.	Input voltage range: 0~10V (input resistance: 30kΩ) Reference ground: GND
Analog output	AO	Analog output	Be able to output analog voltage/current. Voltage or current are selected by DIP switch SW2. It represents 14 kinds of signals. It is shown in instructions in function code P4.21.	Output voltage range: 0/2~10V Output current range: 0/4~20mA Reference ground: GND
Communication	485+	RS485 communication interface	485 differential signal positive terminal	Standard RS-485 communication interface, Not isolated to GND Please use twisted-pair cable or shielded cable
	485-		485 differential signal negative terminal	

Category	Terminal label	Name	Description of terminal function	Specification
Multi-function input terminal	X1	Multi-function input terminal 1	It can be defined as a multi-function discrete input terminal through programming, Please refer to Section 5.4 I/O terminals control (Group P3) for details.	Optical-isolator input Input resistance: $R=3.9k\ \Omega$ Max input frequency: 400Hz/50kHz(S21R5GB, S22R2GB, 3R75GB/31R5PB and above) Input voltage range: 0~30V Reference ground: COM
	X2	Multi-function input terminal 2		
	X3	Multi-function input terminal 3		
	X4	Multi-function input terminal 4	Terminals X4 can be used as common multi-function terminals (same with X1~X3), it can also be used as high speed pulse input port (except S2R4GB, S2R75GB). Please refer to Section 5.4 I/O terminals control (Group P3) for details.	Optical-isolator input Input resistance: $R=3.9k\ \Omega$ Max input frequency: 400Hz/50kHz(S21R5GB, S22R2GB, 3R75GB/31R5PB and above) Input voltage range: 0~30V Reference ground: COM
Multi-function input terminal	X5	Multi-function input terminal 5	Terminals X5 can be used as common multi-function terminals (same with X1~X3), it can also be used as high speed pulse input port. Please refer to Section 5.4 I/O terminals control (Group P3) for details	Opto-coupler isolation input Input impedance $R = 3.9k\Omega$ Maximum input frequency: 50kHz Input voltage range: 0~30V Reference ground: COM

Category	Terminal label	Name	Description of terminal function	Specification
Multi-function input terminal	X6 (S2R4GB, S2R75GB have no X6)	Multi-function input terminal 6	Terminals X6 can be used as common multi-function terminals (same with X1~X3), it can also be used as high speed pulse input port. Please refer to Section 5.4 I/O terminals control (Group P3) for details.	Opto-coupler isolation input Input impedance R = 3.9kΩ Maximum input frequency: 50kHz Input voltage range: 0~30V Reference ground: COM
Multi-function output	DO	Open collector output terminal	It can be defined as a multi-function output terminal for pulse signal through programming. It can also be used as an on-off output terminal. Please refer to Section 5.4 I/O terminals control (Group P3) for details.	Opto-coupler isolated open collector output. Range of operating voltage: 0V~26V Maximum output current: 50mA Range of Output frequency: 0~50kHz Reference ground: COM
Relay output	TA	Relay output	It can be defined as a multi-function relay output terminal through programming, Please refer to Section 5.4 I/O terminals control (Group P3) for details.	TA-TB: NC; TA-TC: NO. Contact capacity: 250VAC/2A (COSΦ=1.0) 250VAC/1A (COSΦ=0.4) 30VDC/1A
	TB			
	TC			
Power	10V	+10V power supply	Provide +10V power supply externally (Reference ground: GND)	Maximum output current 20 mA Open circuit voltage can be up to 12V
	24V	+24V power supply	Provide +24V power supply externally (Reference ground: COM)	Maximum output current 100mA

Category	Terminal label	Name	Description of terminal function	Specification
Power	GND	+10V Reference GND	Reference GND for analog signal and +10V power supply	Inner Isolated from COM COM for +10V, AI1, AI2, and AO1
	COM	+24V Common GND	Used with other terminals	Isolated from GND
	PE	Shield ground	It is used for grounding of terminal wiring shield layer. Shield layer of analog signal lines, 485 communication lines, and motor cables can be connected to this terminal	It is internally connected to connection terminal PE of main circuit.

2.4.2 Wiring of Control Circuit Terminals

• Wiring of Analog Input Terminals

AI1 terminals accept analog signal input, DIP switch SW3 select the input voltage (0 ~ 10V) or the input current (0 ~ 20mA). The wiring of terminals is shown in Fig. 2-17:

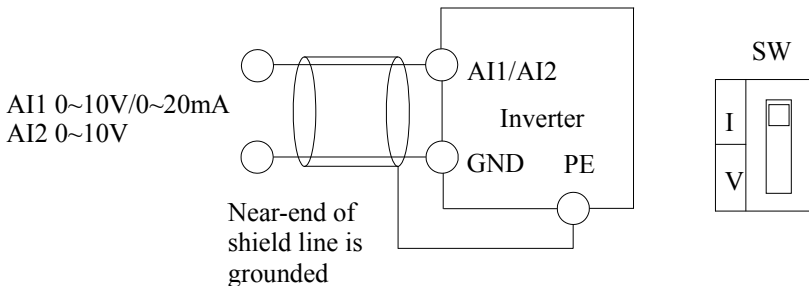

Fig. 2-17 Wiring diagram of analog input terminals

• Wiring of Analog Output Terminal

If the analog output terminal AO1 is connected to analog meters, then various kinds of physical values can be indicated. The analog output terminal AO1 is only support the voltage signal output, for S2R4GB and S2R75GB, for S21R5GB, S22R2GB, 3R75GB and above, DIP switch SW2 can select current output (0/4~20mA) and voltage output(0/2~10V). The wiring of terminals is shown in Fig. 2-18:

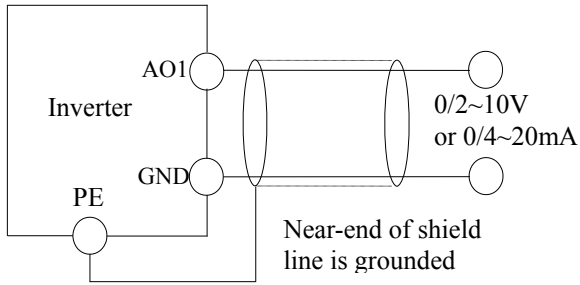

Fig. 2-18 Wiring diagram of analog output terminals

Tips

- 1) Dialing SW2, SW3 to “I” represents current; dialing to “V” represents voltage.
- 2) Analog input and output signals are easily disturbed by exterior environment, so shielded cables must be used for wiring and the length of the cables should be as short as possible.

• Wiring of Serial Communication Interface

The series of inverters provides users with RS485 serial communication interface, and can compose master-slave control system. The upper computer (a personal computer or PLC controller) can be used for real-time monitoring, implementation remote control , automatic control and others more complicated operations to inverters in network.

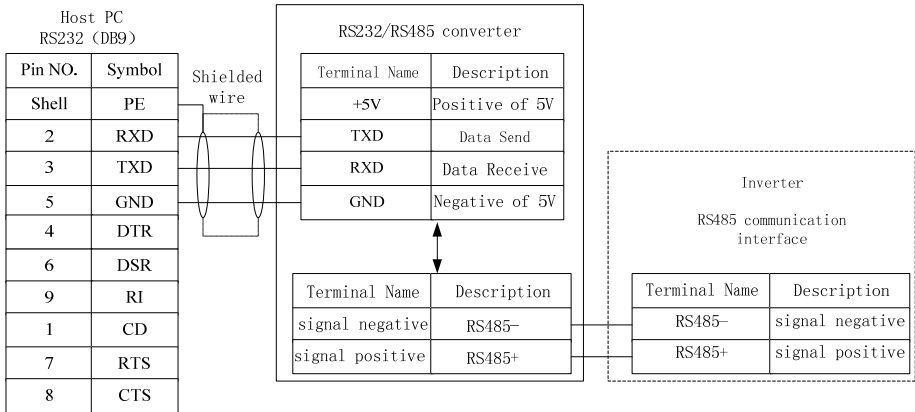

Fig. 2-9 Illustration of wiring between the upper computer and the inverter interface

When multiple inverters are connected in one RS485 system, the communication suffers more interference, and a maximum of 31 inverters can be connected through RS485 serial bus. Wiring is very important. Communication bus must be shielded twisted pair wiring. The following connection method is recommended:

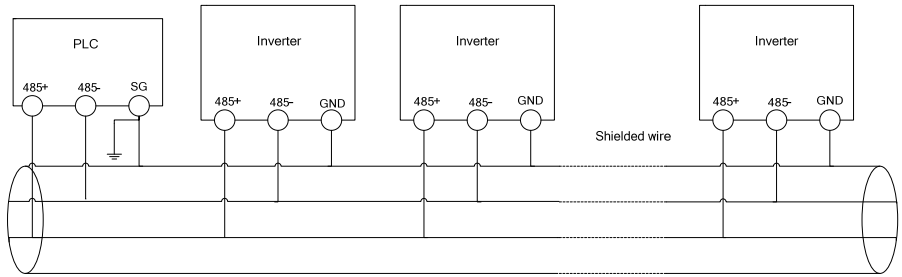
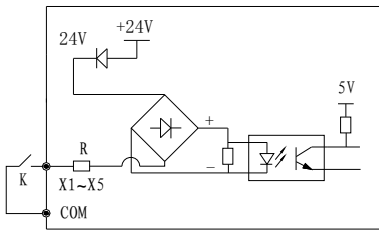

Fig. 2-20 Recommended wiring diagrams (inverters and motors are all well grounded) when PLC is in communication with multiple inverters

The host machine can be a personal computer or PLC controller, and the slave-based machine is this series of inverter. When a PC is used as the host machine, a RS232/RS485 bus adapter should be added between the host machine and the bus; when a PLC controller is used as the host machine, connect the dotted terminals, namely RS485 terminal of slave-based machine and RS485 terminal of the host machine.

● Multi-Function Input Terminal Wiring

Dry Contact Way



Source (Drain Electrode) Mode

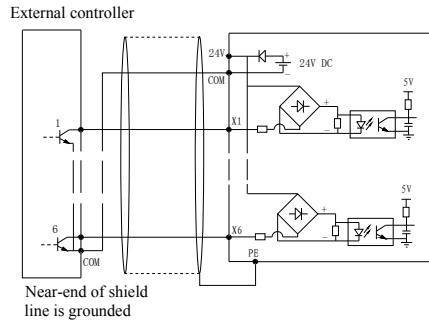

Fig. 2-21 Wiring diagram of multi-function input terminals

● Wire Multi-Function Output Terminals

1) Multi-function output terminals DO as discrete output can use the internal 24V power supply of inverter and the wiring method is shown in Fig. 2-22.

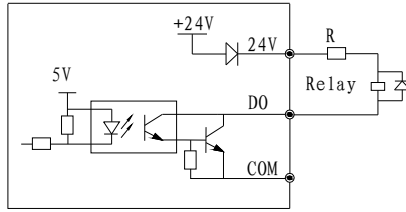

Fig. 2-22 On-off output connection mode 1 of multi-function output terminals

2) Multi-function output terminals DO as discrete output can also use the external, 9~30V, power supply and the wiring method is shown in Fig. 2-23

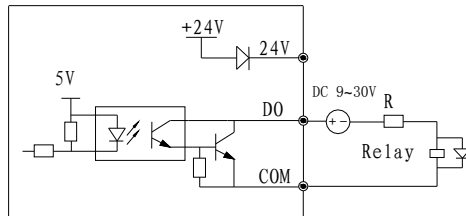

Fig. 2-23 On-off output connection mode 2 of multi-function output terminals

● Wiring of Relay Output Terminals TA, TB, TC

To drive inductive loads (e.g. electromagnetic relays, contactors), it is suggested to add surge voltage absorption circuit, such as the RC absorption circuit, piezoresistor or flywheel diode (pay attention to the diode polarity when used for DC electromagnetic circuit), etc. Components of absorption circuit should be installed close to both ends of coil of relay or contactor.

Tips

1. Don't short circuit terminals 24V and COM, otherwise the control board may be damaged.
2. Please use multi-core shielded cable or multi-stranded cable (above 1 mm) to connect the control terminals.
3. When using a shielded cable, the shielded lay's end that is nearer to the inverter should be connected to PE.
4. The control cables should be as far away (at least 30 cm) from the main circuit and high-voltage cables as possible (including power supply cables, motor cables, relay cables and cables of contactor). The cables should be vertical to each other to reduce the disturbance to minimum.

Keypad connection interface (S2R4GB, S2R75GB: CN2, others: CON15) on the control board adopts RJ-45 fool-proof ports. The control board and key board are connected by RJ-45 plug under default condition. Users can customize extended

keypad cable according to actual needs. But the keypad extension cable shall not exceed 1 m, because when it exceeds 1 m, normal work cannot be guaranteed.

The cables connecting keypad and control board use standard Cat-5e network cable. RJ-45 Interface uses direct connection, namely both sides are connected according to EIA/TIA568B standard. Users can make keypad connection cable by themselves.

2.5 Wiring of Inverter for Basic Operation

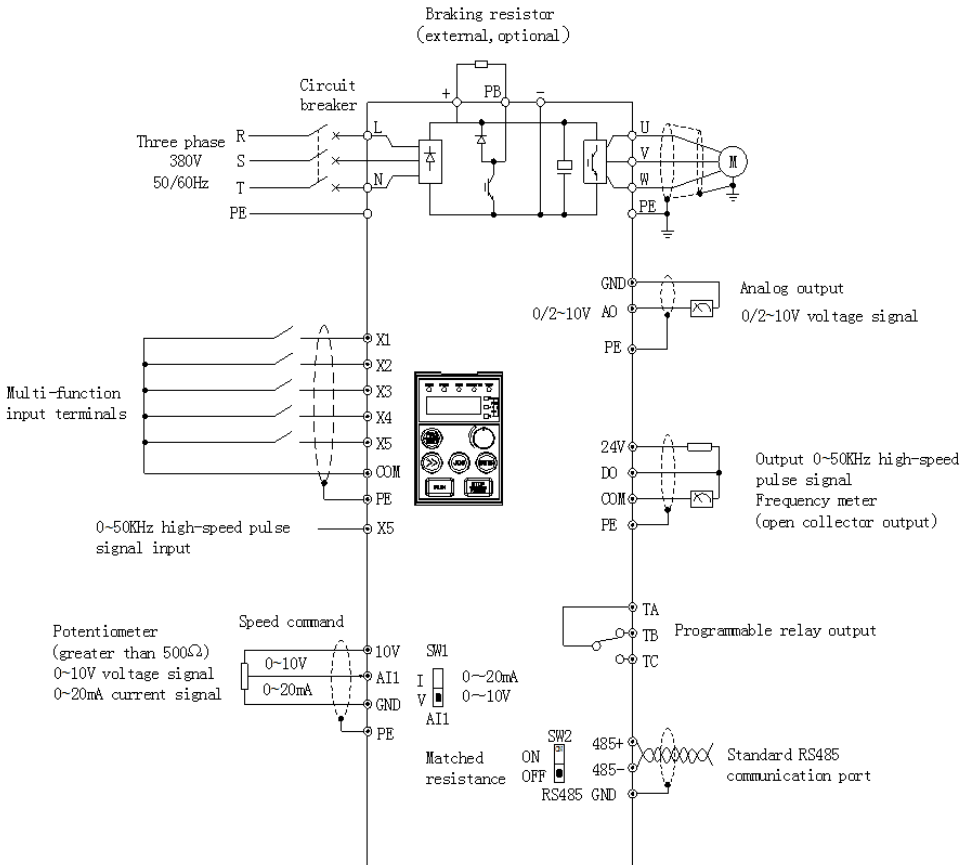

Fig. 2-24 wiring diagram



2.6 Wiring Attention

- Be sure the input power supply of the inverter is cut off then you can remove or replace the motor.
- Be sure the inverter has stopped output then you can switch the motor or switch to

mains power supply.

- If a peripheral (brake unit, reactor and filter) is added, test the insulation resistance of the peripheral to earth first and be sure the value not below 4 MΩ.
- Besides shielding the input signal cable and the cable of frequency meter, the cables should be disposed solely, not parallel with the main circuit cable, and far away from it as possible.
- In order to avoid error action caused by interference, the control circuit cable should use stranding shielded cables, and the wiring distance should be less than 50 meters.
- Be sure the shielded layers of shielded cables are not touching other signal cables or shell of equipment, you can use insulating tape to enswathe bare shielding layer.
- The withstand voltage of all the cables should match with the voltage class of the inverter.
- In order to prevent accident, be sure that the control circuit terminal "PE" and the main circuit terminal "PE" are connected to earth, and the earthing cable can't be shared with other equipment. The size of main circuit earthing cable should be more than one and a half of the main circuit cable. After completion of wiring, please check whether a cable, a bolt or a connector etc. is left inside the inverter, whether the bolts are fastened firmly, and whether the bare cable of terminals short circuit to other terminals.

Chapter 3 Operation

 DANGER	<ol style="list-style-type: none"> 1 Only turn on the input power supply after close the front cover. Do not remove the cover while the inverter is powered on. Otherwise there is risk of electric shock. 2 Keep away from the machinery. Otherwise there is risk of injury when the inverter power supply recovers and runs suddenly.
 CAUTION	<ol style="list-style-type: none"> 1 When braking resistor is used, the high voltage discharging at its two ends will increase its temperature. Do not touch the braking resistor to avoid danger of electric shock and burn. 2 Before running the inverter, do check again the motor and machinery operating precautions to avoid risk. 3 Do not check signals during operation. It may damage the equipment. 4 All inverter parameters have been preset at the factory. Do not change the settings unless it is required.

3.1 Function and Operation of Keypad

The keypads of the different power rating inverters may have different exterior dimensions. However, all of them have the same array of buttons and LED display. Moreover, operation and function of them are all the same. Every keypad has a LED monitor of 4 digits with 7 segments, buttons, a digital encoder, and LED indicators. User can perform function setting, inverter running, stop, and status monitoring with the keypad.

3.1.1 Keypad Layout

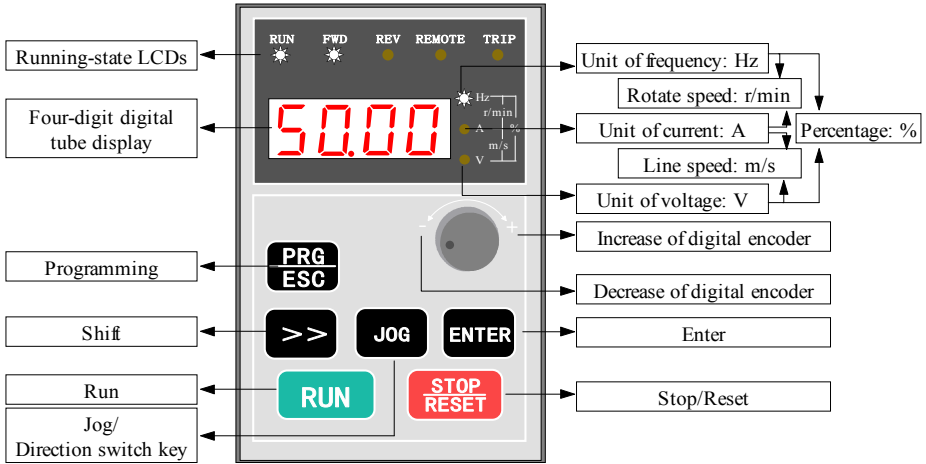

Fig. 3-1 Keypad layout and name of each part

Keypad upper part has five status indicators: RUN, FWD, REV, REMOTE and TRIP. The indicator RUN will be lit up if the inverter is running; the indicator FWD will be lit up if it running forward and the indicator REV will be lit up if it runs reverse. The indicator REMOTE will be lit up if the inverter is not controlled by keypad. The indicator TRIP will be lit up if fault occurs. To see the details, see table 3-2 description.









In monitoring status, the LED will display the status of monitored objects. At abnormal state it will display the fault code when the inverter fails to run and show the warn code when the inverter is warning. At normal state, it will display the object selected by parameter group PC. Refer to the detailed description of PC groups for the specific corresponding relation.

In programming mode, nixie tube displays three-level menus: function group, function codes and function parameter values. Under the function group display menu, it displays function group from "-P0-" to "-PF-"; under function code menu, it displays the corresponding function codes in the group. Under the parameters displayed in the function menu, the parameter values will be displayed.

3.1.2 Description of Button Function

On the inverter keypad, there are eight buttons. In addition, the function of each button is defined as table 3-1.

Table 3-1 Keypad menu

key	Name of key	Key functions
	Programming /Exit	Enter or exit programming mode. In monitoring mode, press PRG/ESC key to switch to programming mode. First, enter function group, and press ENTER key to enter function code and then function parameters progressively; press PRG/ESC, it will exit from function parameters to function code, then function group, next monitoring state, exit step by step like this; in case of an inverter failure, it can switch failure display and function group. When giving an alarm, switch alarm state and function group.
	Enter	Enter the sub-menu, or store parameters during parameter setting.
Digital encoder 	Up (clockwise) 	It can increase the function group number, function code number or function code value. In parameter setting mode, LED nixie tube blinking displays modified digit. If turn the knob clockwise, the function code value will increase; in display mode, if the keypad is set to be effective, digital frequency setting, speed PID setting or analog PID digital setting can be increased.
	Down (counterclockwise) 	It can reduce the function code group number, function code number or function code value. In parameter setting mode, LED nixie tube blinking displays modified bit. If turn the knob CCW, the function code value will decrease; in display mode, if the keypad is set to be effective, digital frequency setting, speed PID setting or analog PID digital setting can be decreased.
	Shift	In edit mode, the modified digit of the set data can be selected; In monitoring mode, displayed parameters can be switched.
	P2.51=0	Jog: In keypad mode, press this key to enter JOG running mode.
	P2.51=1	Direction switch key: Press this button to change the direction of rotation. See P0.08 function description for details.
	Run	In keypad control mode, it is to run the inverter, and a running command will be given.
	Stop/Reset	In keypad control mode, the key is used to stop the inverter. Clear the failure and return to normal state when there is a failure.

3.1.3 Description of LED Digital Tube and Indicators

On the inverter keypad there are four digits seven segments LEDs, 3 unit indicators, 5 status indicators. The LED can display the monitoring object, the function parameter values, the fault code, and the warning code. The three unit indicators have eight combinations, and each combination corresponds to one-unit. The combinations and their corresponding units are as Fig. 3-2.

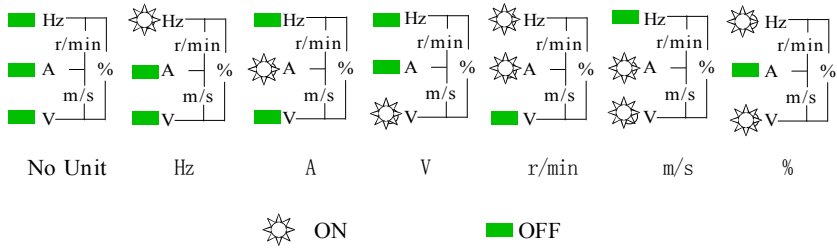

Fig. 3-2 Combinations of unit indicator and their means

The five status indicators are just above the LED and the meaning of each indicator is shown in table 3-2

Table 3-2 Description of state indicators

Indicator	Display state	The current state of the inverter indicated
RUN Running-state indication	Off	Stop
	On	Running
	Flicker	Zero frequency operation
FWD Forward running direction indication	Off	Reverse rotation or not run
	Normally on	Stable forward rotation
	Quick flicker	Acceleration and deceleration of forward rotation
	Slow flicker	Going to stop, the direction is forward
REV Reverse running direction indication	Off	Forward rotation or not run
	Normally on	Stable reverse rotation
	Quick flicker	Acceleration and deceleration of reverse rotation
	Slow flicker	Going to stop, reverse direction
TRIP failure indicator	Off	Normal
	Flicker	Failure
REMOTE indicator (Exclusive for control keypad)	Off	Keypad control state
	On	Terminal control state
	Flicker	Serial communication state

3.1.4 Operation Method of Keypad

Here are some examples of how to run the inverter by the keypad:

Monitoring object switching:

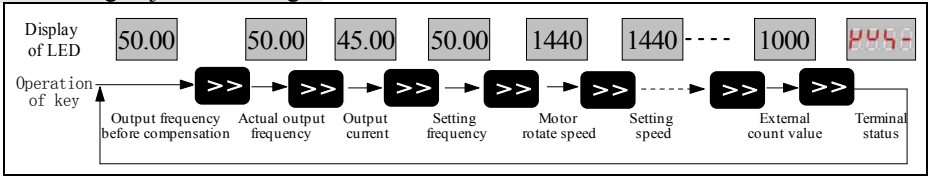

Fig. 3-3 Operation of parameters display at running/stop status

Frequency adjustment at common running: (Example: change the setting frequency from 50.00 Hz to 40.00 Hz)

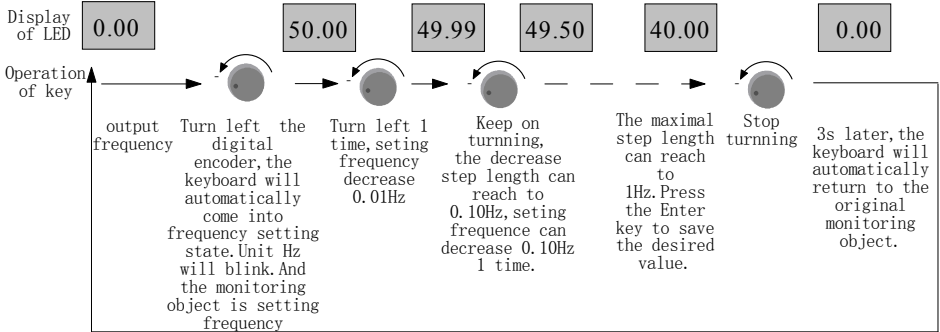

Fig. 3-4 Flow chart of frequency setting

This method applies to given frequency parameter adjustment when the initial display state is any state.

When the monitor display is speed setting and analog PID digital setting, these parameters can be modified and displayed directly by turning the knob.

Setting of function code parameters: (example of changing Jog acceleration time, function code P2.01 from 6.0s to 3.2s)

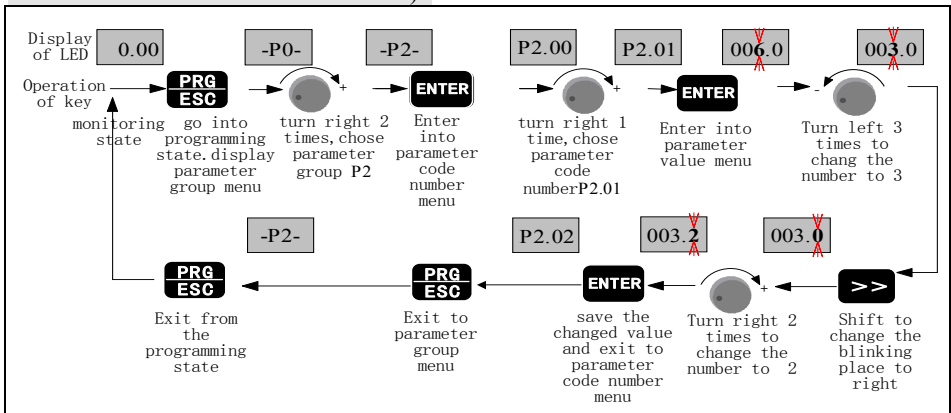

Fig. 3-5 Flow chart of parameter setting

In three-level menu state, no flicker digit for a parameter indicates that the function code cannot be modified, and the possible reasons include:

- ◆ Modifying the value is forbidden because the parameter is actual measure value, or running record value or fixed value.
- ◆ The function parameter cannot be changed when the inverter is at running state. However, it can be changed at stop state. So stop the inverter and then change the parameter value.
- ◆ The inverter parameters are protected. If function parameter value PF.01=1 or 2, the parameters are forbidden to be changed. This parameter protection function is to avoid operation mistake. To change the protection parameters, change value of function code PF.01 to zero, then all the parameters can be changed

3.2 Run Command Mode Select

The run command modes determine the methods of the inverter running and stop. The inverter has three run command modes:

- Run command from the keypad: press the key RUN, STOP, JOG(P2.51=1) to control the inverter.
- Run command from the control circuit terminals: by using the terminal defined as FWD, REV, COM (2-wire control mode) : FWD, REV, HLD(3-wire control mode) to control the inverter.
- Run command from serial communication: Use a PC or PLC to control the inverter to run or stop.

Change P0.07 to switch the control modes. The default setting is Keypad control mode (The default value P0.07 is 0), If terminal control mode is needed, please change the value to 1 or 2. If we want to keep the “STOP/RESET” key active in terminal control mode, we must set the value to 2.

If we need to control the inverter by PC or PLC serial communication, we should set P0.07 to 3 or 4.

If the indicator REMOTE is off, it tells that the inverter is controlled by the keypad. If the indicator REMOTE is on, it tells that the inverter is controlled by the terminals. In addition, if the indicator is flickering, it tells the inverter is controlled by serial communication.

3.3 Trial Operation

3.3.1 Operation Mode of Inverter

This series of inverter have five operation modes: JOG operation, PID closed loop operation, PLC programmed operation and common operation.

- ◆ JOG operation: If the inverter received a jog operation command (For example, press “JOG” key, P2.51=0) at a stop state, the inverter will jog running at the jog frequency reference set by function code P2.00~P2.02
- ◆ PID closed loop operation: If PID close loop operation is selected (P0.03=11) , the inverter will choose PID closed loop operation mode. In other word, it will come into PID adjustment as the PID feed and PID feedback. (See parameter group P7)

-
- ◆ PLC program timing run: PLC function selection is active (P0.03 = 10), the inverter will select PLC operating mode, and the inverter will run according to the preset operating mode (see Description of Group P5 function code). PLC program running can be paused through the No.43 function of multi-function terminal (see Chapter IV Function of P3); PLC halt mode can be reset through the No.44 function of multi-function terminal (For details please see Chapter IV Function of P3);
 - ◆ Normal operation: It is known as simple open-loop operation mode, including 8 modes, which are keypad digital setting, terminal AI1, terminal AI2, pulse input, serial communication, Multi-step speed and terminal UP/DOWN, slip compensation rate, etc.

3.3.2 Operation of Initial Power On

Please follow technical requirements provided in this manual for wiring and connections. After correct wiring and checking power supply, power on air switch of AC power on input side of the inverter to supply power to the inverter, the contactor operates normally. When nixie tube displays output frequency, the inverter has been initialized.

If the keypad is not correctly connected, the display will be abnormal. And the keypad should be reconnected. Operation of initial power on is shown in Fig. 3-6:

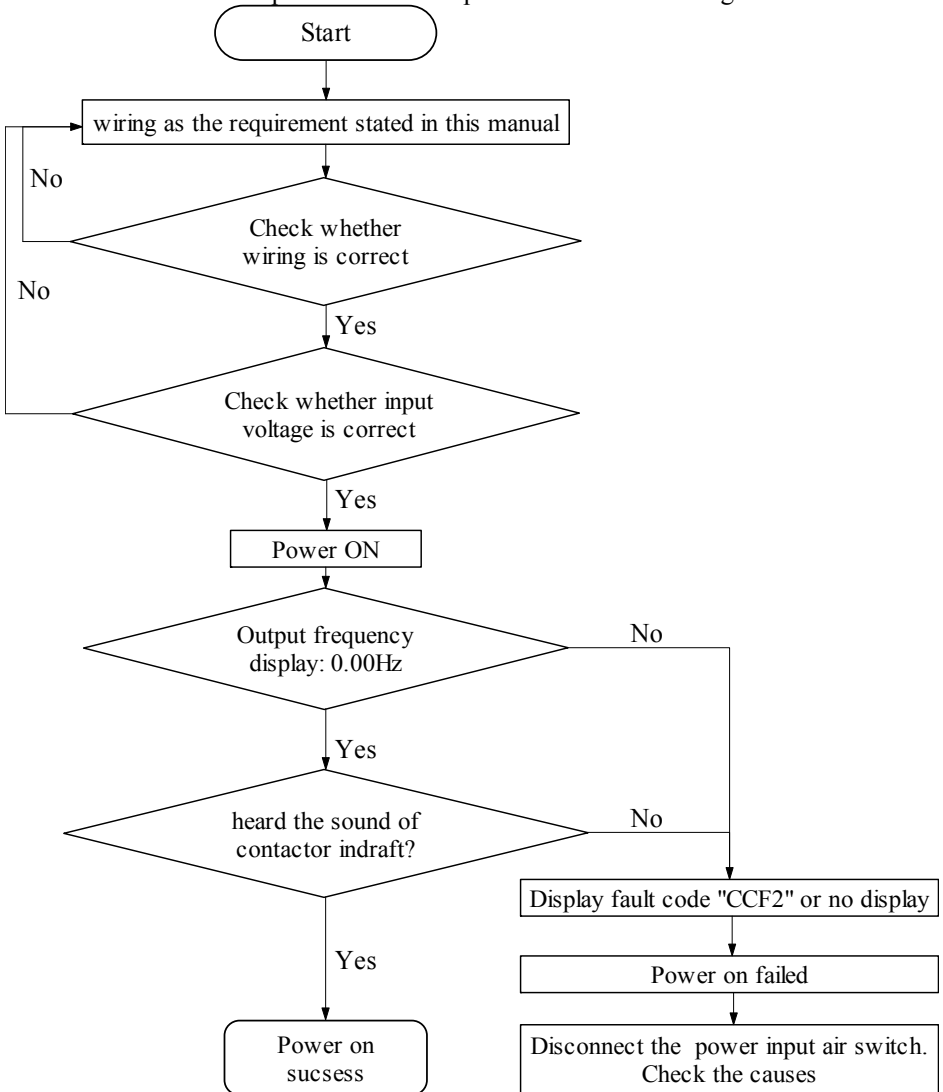

Fig. 3-6 Operation process of initially powering on the inverter

3.3.3 First Test Run Operation

Please perform the first test run operation according to the following processes.

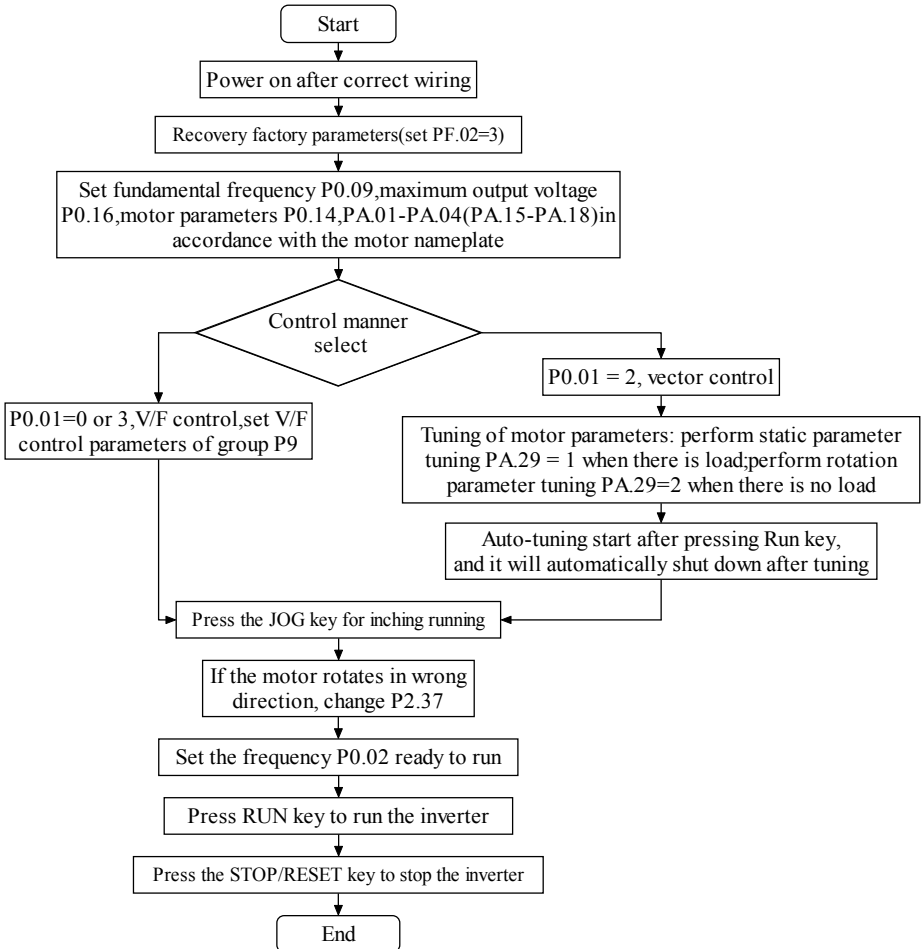

Fig. 3-7 Operation process of inverter first test run operation

Chapter 4 Parameter Index

Notes:

- “○” means that the parameters can be changed during inverter running and stop state;
- “×” means that the parameters cannot be changed during running;
- “*” means that the parameters are actually measured value or fixed parameters which cannot be changed;
- “-” means that the parameters can only be set by the manufacturer and cannot be changed by the users.

P0: Basic Function

Depend on model

Function code	Parameter	Setting range	Factory setting	Modify flag	Modbus address
P0.00	Menu display mode	0: Standard menu 1: Check mode menu	0	○	0100
P0.01	Control mode	0: V/F control 1: Reserve 2: Sensor-less vector control (SVC) 3: V/F separation control (S2R4GB or S2R75GB: no SVC, it cannot set to 2)	0	×	0101
P0.02	Frequency digital setting	0.00Hz ~ maximum frequency	0.00Hz	○	0102
P0.03	Frequency setting source 1	0: NULL 1: Frequency digital setting, digital knob adjustment 2: Terminal AI1 3: Terminal AI2 (S2R4GB and S2R75GB have no AI2) 5: Pulse input 6: Communication setting 8: Multi-step speed 9: Terminal UP/DOWN 10: Program timing controller (PLC) 11: PID 4/7: Reserve	1	×	0103

Function code	Parameter	Setting range	Factory setting	Modify flag	Modbus address
P0.03	Frequency setting source 1	(Contd.) When the frequency source is 0 ~ 7, if Multi-step speed terminals are effective, operate according to the operation process of "Multi-step speed"	1	×	0103
P0.04	Frequency setting source 2	0~8, consistent with P0.03 9: Torque deviation compensation amount This frequency source has no Multi-step speed terminal priority mechanism.	0	×	0104
P0.05	Frequency setting combination 1	0: Frequency setting by source 1 only 1: Frequency setting by source 2 only 2: MIN [frequency by source 1, frequency by source 2] 3: MAX [frequency by source 1, frequency by source 2] 4: Frequency by source 1 + frequency by source 2 5: Frequency by source 1 - frequency by source 2 6: Frequency by source 1 * frequency by source 2 7: Frequency by source 1 / frequency by source 2 8: Frequency by source 1 - frequency by source 2 9: Frequency by source 2 * (maximum output frequency + frequency by source 1) / maximum output frequency	0	×	0105

Chapter 4 Parameter Index

Function code	Parameter	Setting range	Factory setting	Modify flag	Modbus address
P0.06	Frequency setting combination 2	0~9, ditto. It is valid when FC terminal is defined and effective.	0	×	0106
P0.07	Control command set channel	0: Keypad control 1: Terminal control 1 (STOP key is inactive) 2: Terminal control 2 (STOP key is enabled) 3: Serial communication 1 (STOP key is inactive) 4: Serial communication 2 (STOP key is enabled) 5: Terminal control 3 (STOP and JOG keys are inactive)	0	○	0107
P0.08	Keypad direction setting	0: Forward rotation 1: Reverse rotation	0	○	0108
P0.09	Basic frequency	low frequency mode: 0.10~400.0Hz high frequency mode(reserve): 0.1~1000Hz	50.00Hz	×	0109
P0.10	Maximum output frequency	low frequency mode: MAX [50.00Hz, upper limit frequency, digital setting frequency, Multi-step frequency, jump frequency] ~ 400.0Hz high frequency mode(reserve): MAX [50.0Hz, upper limit frequency, digital setting frequency, Multi-step frequency, jump frequency] ~ 1000Hz	50.00Hz	×	010A

Function code	Parameter	Setting range	Factory setting	Modify flag	Modbus address
P0.11	Upper limit frequency setting source	0: Digital setting 1: Terminal AI1 2: Terminal AI2 (S2R4GB and S2R75GB have no AI2) 3: Reserve 4: Pulse input 5: Communication setting	0	×	010B
P0.12	Upper limit frequency setting	MAX [lower limit frequency, jog frequency, UP/DN given amplitude, sleep threshold] ~ maximum frequency	50.00Hz	○	010C
P0.13	Offset of upper limit frequency	0.00Hz~upper limit frequency	0.00Hz	○	010D
P0.14	Rated voltage of motor	60~480V	Rated voltage	×	010E
P0.15	Lower limit frequency	0.00Hz~upper limit frequency	0.00Hz	○	010F
P0.16	Maximum output voltage	60~480V	Rated voltage	×	0110
P0.17	Keypad knob adjusting rate	0: Keypad knob integral regulation; (1~250) * (0.01Hz 1rpm)	0	×	0111
P0.18	Acceleration time 1	≤132kW 0.1~3600s ≥160kW 1.0~3600s	22kW and below: 6.0s Others: 20.0s	○	0112
P0.19	Deceleration time 1	≤132kW 0.1~3600s ≥160kW 1.0~3600s	22kW and below: 6.0s Others: 20.0s	○	0113

P1: Start-stop control

Function code	Parameter	Setting range	Factory setting	Modify flag	Modbus address
P1.00	Start mode	0: Start from the start-up frequency 1: First brake (excitation), and then start at the start-up frequency 2: Speed tracking restart mode 1(needs to connect PG or speed tracking board. 3004GB and below power do not have this function) 3: Speed tracking restart mode 2(software) Note: The startup procedure includes initial power-on, power restoration after instantaneous stop, external fault reset, and all startup procedure after coast-to-stop	0	○	0200
P1.01	Start-up frequency	0.10~60.00Hz	0.50Hz	○	0201
P1.02	Start-up frequency hold time	0.0~10.0s	0.0s	○	0202

Function code	Parameter	Setting range	Factory setting	Modify flag	Modbus address
P1.03	DC braking current at start-up	G type: 0~100.0% of inverter rated current P type: 0~80.0% of inverter rated current 0~100.0% of rated current of the motor. It is active only in V/F control mode, the upper limit is the smaller one between 80% of inverter rated current and full motor rated current; in vector control mode, the current is determined by P8.00 pre-excitation current compensation factor; when the set value is less than 100%, perform it at 100%	0.0%	○	0203
P1.04	Start-up DC braking hold time	0.0~30.0s	0.1s	○	0204
P1.05	Starting preset frequency	0.00~maximum frequency	0.00Hz	×	0205
P1.06	Starting preset frequency hold time	0.0~3600.0s	0.0s	×	0206
P1.07	Acceleration and deceleration mode	0: Linear 1: S curve 2: (Reserve) 3: (Reserve)	0	○	0207
P1.08	S curve start time	10.0~50.0 % (acceleration and deceleration time) P1.08+P1.09<90%	20.0%	○	0208
P1.09	S curve ascending stage time	10.0~80.0 % (acceleration and deceleration time) P1.08+P1.09<90%	60.0%	○	0209
P1.10	Stop mode	0: Deceleration stop 1: Free stop 2: Deceleration + DC braking	0	×	020A

Chapter 4 Parameter Index

Function code	Parameter	Setting range	Factory setting	Modify flag	Modbus address
P1.11	Stopping DC braking frequency	0.00~MIN(50.00Hz, upper limit frequency)	1.00Hz	○	020B
P1.12	Waiting time before stopping DC braking	0.00~10.00s	0.00s	○	020C
P1.13	Setting source of stopping DC braking current	0: Digital setting 1: Terminal AI1 2: Terminal AI2 (S2R4GB and S2R75GB have no AI2) 3: Reserve 4: Pulse input 5: Communication setting Rated current of the motor is 100% current	0	○	020D
P1.14	Digital setting of Stopping DC braking current	0.0~100.0% motor rated current	0.0%	○	020E
P1.15	Stopping DC braking time	0.0~30.0s	0.0s	○	020F
P1.16	Stopping holding frequency	0.00~maximum frequency	0.00Hz	×	0210
P1.17	Stopping holding Time	0.0~3600.0s	0.0s	×	0211
P1.18	Braking selection	0: Do not use brake 1: Use energy consumption braking 2: Use magnetic flux braking 3: Use energy consumption and magnetic flux braking	3	×	0212
P1.19	energy consumption braking usage	30.0%~100.0% Note: It is active for 3015GB and below built-in models of this series; automatically add dynamic braking in deceleration	100.0%	×	0213

Function code	Parameter	Setting range	Factory setting	Modify flag	Modbus address
P1.20	Trip-free handling	0: Report fault Uu1 once trip-free 1: Give an alarm Uu within trip-free time, and give fault Uu1 afterwards 2: Give an alarm Uu once trip-free	0	×	0214
P1.21	Trip-free time	0.5~10.0s	Depend on model	×	0215
P1.22	Action selection after trip-free alarm	0: No action 1: Slowdown running	0	○	0216
P1.23	Rate of deceleration during trip-free slowdown running	0.00Hz/s ~ maximum frequency/s	10.00 Hz/s	○	0217

P2: Auxiliary Run

Function code	Parameter	Setting range	Factory setting	Modify flag	Modbus address
P2.00	Jog frequency	0.10Hz~upper limit frequency	5.00Hz	○	0300
P2.01	Jog acceleration time	≤132kW 0.1~3600s ≥160kW 1.0~3600s	22kW and below: 6.0s Others: 20.0s	○	0301
P2.02	Jog deceleration time	≤132kW 0.0~3600s ≥160kW 0, 1.0~3600s Note: If the deceleration time is 0, Coast-to-stop mode is adopted.	22kW and below: 6.0s Others: 20.0s	○	0302
P2.03	Switching time between run forward and reverse	0.0~3600.0s	0.0s	○	0303

Chapter 4 Parameter Index

Function code	Parameter	Setting range	Factory setting	Modify flag	Modbus address
P2.04	Lower limit frequency handling mode	0: Running at lower limit frequency 1: Running at 0 frequency 2: Stopping 3: Reserve	0	×	0304
P2.05	Frequency deviation setting	0.00~2.50Hz	0.10Hz	○	0305
P2.06	Carrier frequency adjustment selection	0: No automatic adjustment 1: Adjust automatically according to the load and the temperature of the inverter It is the carrier frequency in vector control mode or when there is no automatic adjustment	0	○	0306
P2.07	Carrier frequency	Depend on model	Depend on model	×	0307
P2.08	Lower limit of carrier frequency	1.0kHz~P2.07	1.0 kHz	×	0308
P2.09	Jump frequency 1	0.00~maximum frequency	0.00Hz	×	0309
P2.10	Jump frequency 2	0.00~maximum frequency	0.00Hz	×	030A
P2.11	Jump frequency 3	0.00~maximum frequency	0.00Hz	×	030B
P2.12	Jump frequency amplitude	0.00~15.00Hz	0.00Hz	×	030C
P2.13	Multi-step frequency 1	0.00~maximum frequency	5.00 Hz	○	030D
P2.14	Multi-step frequency 2		8.00 Hz		030E
P2.15	Multi-step frequency 3		10.00 Hz		030F
P2.16	Multi-step frequency 4		15.00 Hz		0310

Function code	Parameter	Setting range	Factory setting	Modify flag	Modbus address
P2.17	Multi-step frequency 5	0.00~maximum frequency	18.00 Hz	○	0311
P2.18	Multi-step frequency 6		20.00 Hz		0312
P2.19	Multi-step frequency 7		25.00 Hz		0313
P2.20	Multi-step frequency 8		28.00 Hz		0314
P2.21	Multi-step frequency 9		30.00 Hz		0315
P2.22	Multi-step frequency 10		35.00 Hz		0316
P2.23	Multi-step frequency 11		38.00 Hz		0317
P2.24	Multi-step frequency 12		40.00 Hz		0318
P2.25	Multi-step frequency 13		45.00 Hz		0319
P2.26	Multi-step frequency 14		48.00 Hz		031A
P2.27	Multi-step frequency 15		50.00 Hz		031B
P2.28	Acceleration time 2	$\leq 132\text{kW}$ 0.1~3600s $\geq 160\text{kW}$ 1.0~3600s	22kW and below: 6.0s Others: 20.0s	○	031C
P2.29	Deceleration time 2				031D
P2.30	Acceleration time 3				031E
P2.31	Deceleration time 3				031F
P2.32	Acceleration time 4				0320
P2.33	Deceleration time 4				0321
P2.34	Deceleration time during abnormal stopping	$\leq 132\text{kW}$ 0.1~3600s $\geq 160\text{kW}$ 1.0~3600s	22kW and below: 3.0s Others: 10.0s	○	0322

Chapter 4 Parameter Index

Function code	Parameter	Setting range	Factory setting	Modify flag	Modbus address
P2.35	Multiplying factor of acceleration and deceleration time	0: 1 times 1: 10 times 2: 0.1 times	0	×	0323
P2.36	Cooling Fan control mode	0: Auto stop mode 1: Keep Running after power on	0	×	0324
P2.37	Wiring direction of motor	0: Positive sequence 1: Inverted sequence	0	×	0325
P2.38	Anti-reverse selection	0: Reverse rotation is enabled 1: Reverse rotation is disabled	0	×	0326
P2.39	Reserve	-	-	*	0327
P2.40	Reserve	-	-	*	0328
P2.41	Reserve	-	-	*	0329
P2.42	Reserve	-	-	*	032A
P2.43	Reserve	-	-	*	032B
P2.44	Built-in PG pulses per revolution	1~9999	1000	×	032C
P2.45	Reserve	-	-	*	032D
P2.46	Reserve	-	-	*	032E
P2.47	PG disconnection detection time (Reserve)	0.0~10.0s	2.0 s	*	032F
P2.48	PG disconnection operation selection (Reserve)	0: Deceleration stopping 1: Coast-to-stop 2: Abnormal stopping 3: Continue to run	1	*	0330
P2.49	Number of PG reduction teeth 1	1~1000	1	×	0331
P2.50	Number of PG reduction teeth 2	1~1000	1	×	0332

Function code	Parameter	Setting range	Factory setting	Modify flag	Modbus address
P2.51	JOG key's_ function selection	0: JOG key 1: FWD/REV key	0	×	0333
P2.52	Keypad keys UP/DN activation	0: Invalid 1: Activation	0	×	0334
P2.53	High / low frequency mode(reserve)	0: low frequency (0.00~400.0Hz) 1: high frequency (0.0Hz~1000Hz)	0	×	0335
P2.54	Reversed rotation upper limit frequency	0.00Hz~maximum frequency note: 0.00Hz means no limit	0.00Hz	○	0336
P2.55	JOG priority enable	0: Invalid 1: Valid	0	×	0337

P3: I / O Terminal Control

Function code	Parameter	Setting range	Factory setting	Modify flag	Modbus address
P3.00	Mode of terminal action	0: Close is active 1: Open is active (normally open / normally closed is not subject to this function)	0	×	0400
P3.01	X1 terminal function	0: NULL Not defined 1: FWD Forward running 2: REV Reverse running 3: RUN Running 4: F/R Rotation direction 5: HLD Self-holding 6: RST Reset 7: FC Frequency setting combination selection 8: FJOG JOG FWD 9: RJOG JOG REV 10: UP 11: DOWN 12: UP/DOWN reset 13: FRE Coast to stop	1	×	0401

Chapter 4 Parameter Index

Function code	Parameter	Setting range	Factory setting	Modify flag	Modbus address
P3.02	X2 terminal function	(Contd.) 14: Forced stopping (According to deceleration time during abnormal stopping) 15: Stopping process DC braking 16: Acc/Dec prohibit 17: Inverter running prohibit 18: S1 Multi-step speed 1 19: S2 Multi-step speed 2 20: S3 Multi-step speed 3 21: S4 Multi-step speed 4 22: S5 Multi-step speed 5 23: S6 Multi-step speed 6 24: S7 Multi-step speed 7	2	×	0402
P3.03	X3 terminal function	25: Command channel switch to terminal control 2 26: SS1 Multi-step speed 27: SS2 Multi-step speed 28: SS3 Multi-step speed 29: SS4 Multi-step speed 30: T1 Acc/Dec time 1 31: T2 Acc/Dec time 2 32: T3 Acc/Dec time 3 33: T4 Acc/Dec time 4 34: TT1 Acc/Dec time 35: TT2 Acc/Dec time 36: Forced stopping normally closed 37: EH0 external fault normally open 41: Stop state DC braking 42: Start PLC operation 43: Pause the PLC operation 44: Reset PLC stop status 47: Start PID operation 48: Speed / torque mode switching 49: Timing driven input	37	×	0403

Function code	Parameter	Setting range	Factory setting	Modify flag	Modbus address
P3.03	X3 terminal function	(Contd.) 50: Counter trigger signal input 51: Counter reset 53: Timing unit selection 74: Output terminal control 77: PID output is forced to 0 78: PID integral time reset 79: Command channel switch to keypad 45/46/52/54~73/75/76: Reserve	37	×	0403
S21R5GB, S22R2GB, 3R75GB/31R5PB and above power:					
P3.04	X4 terminal function	0~79: Ibid 82: double-phase speed measuring input B input	0	×	0404
P3.05	X5 terminal function	0~79: Ibid 80: PULSE input 81: Single-phase speed measuring input. Or double-phase speed measuring input A input	0	×	0405
P3.06	X6 terminal function	0~79: Ibid 80: PULSE input	0	×	0406
S2R4GB, S2R75GB and below power: :					
P3.04	X4 terminal function	0~79: Ibid	0	×	0404
P3.05	X5 terminal function	0~79: ditto. 80: PUL Pulse input 81: Single-phase tachometer pulse	0	×	0405
P3.06	Reserve	-	-	*	0406
P3.07	Reserve	-	-	*	0407
P3.08	Reserve	-	-	*	0408
P3.09	Reserve	-	-	*	0409
P3.10	Reserve	-	-	*	040A
P3.11	Reserve	-	-	*	040B
P3.12	Reserve	-	-	*	040C

Chapter 4 Parameter Index

Function code	Parameter	Setting range	Factory setting	Modify flag	Modbus address
P3.13	X terminal filter time	0.002s~1.000s	0.010s	○	040D
P3.14	Reserve	-	-	*	040E
P3.15	Operation mode setting	0: Two-wire operation mode 1 1: Two-wire operation mode 2 2: Three-wire operation mode 1 - self hold function (add any one of X1 ~ X6) 3: Three-wire operation mode 2 - self hold function (add any one of X1 ~ X6)	0	×	040F
P3.16	Terminal UP / DOWN Speed	0.01~99.99Hz/s	1.00Hz/s	○	0410
P3.17	UP/DN setting amplitude	0.00~upper limit frequency	10.00Hz	×	0411
P3.18	Digital frequency UP / DOWN storage selection	0: UP/DOWN set point is reset to 0 after receiving STOP 1: UP/DOWN set point do not reset to 0 after receiving STOP, which will not save after power off 2: UP/DOWN set point do not reset to 0 after receiving STOP, which will save after power off; when P0.03 is set to 1, P0.02 will be saved while power off	2	×	0412
P3.19	DO terminal function	0: NULL not defined 1: RUN Running 2: FAR frequency arrival 3: FDT frequency detection 4: FDTH upper limit frequency reaching 5: FDTL lower limit frequency reaching 7: Inverter is in zero speed operation	0	×	0413

Function code	Parameter	Setting range	Factory setting	Modify flag	Modbus address
P3.19	DO terminal function	(Contd.) 8: Simple PLC step operation completion indication 9: PLC cycle completion indication 10: Inverter running preparation finished, i.e. Running ready. (RDY) 11: Coast-to-stop 12: Auto restart 13: Timing arrival 14: Counting arrival output 15: Set running time arrival 16: Torque arrival detection 17: CL current-limit action 18: Overvoltage stall 19: Inverter failure 20: External fault stopping (EXT) 21: Uu1 under-voltage stopping 23: OLP2 overload pre-alarm 24: Abnormality of analog signal 1 25: Abnormality of analog signal 2 29: Sleeping 30: Zero speed 33: Actual direction of rotation 35: Underload detection signal (ULP) 36: Multi-step speed 37: Control signal 6/22/26/27/28/31/32/34: Reserve	0	×	0413
P3.20	Reserve	-	-	*	0414
P3.21	Reserve	-	-	*	0415
P3.22	Reserve	-	-	*	0416
P3.23	Reserve	-	-	*	0417

Chapter 4 Parameter Index

Function code	Parameter	Setting range	Factory setting	Modify flag	Modbus address
P3.24	Relay 1 (TA/TB/TC) Output function selection	0~37: the same as P3.19	19	×	0418
P3.25	Reserve	-	-	*	0419
P3.26	Frequency arriving detection width	0.00~10.00Hz	2.50Hz	○	041A
P3.27	FDT level	0.00~maximum frequency	50.00Hz	○	041B
P3.28	FDT lag	0.00~10.00Hz	1.00Hz	○	041C
P3.29	Upper limit frequency arriving output delay time	0.0~100.0s	0.0s	○	041D
P3.30	Lower limit frequency arriving output delay time	0.0~100.0s	0.0s	○	041E
P3.31	Torque detection setting	0.0~200.0%	100.0%	○	041F
P3.32	Counting arriving setting	0~9999	0	○	0420
P3.33	Timing arriving setting	0.0~6553.0	0.0	○	0421
P3.34	Preset operating time	0~65530h	65530h	×	0422
P3.35	Underload detection setting	0.0~200.0%	10.0%	○	0423
P3.36	Underload detection terminal output delay time	0.0~100.0s	5.0s	○	0424

P4: Analog and Pulse Input and Output Terminals

Function code	Parameter	Setting range	Factory setting	Modify flag	Modbus address
P4.00	Analog nonlinear selection	0: None 2: AI2 1: AI1 3: Pulse	0	×	0500

Function code	Parameter	Setting range	Factory setting	Modify flag	Modbus address
P4.01	AI1 minimum analog input value	0.00~P4.03	0.00V	○	0501
P4.02	Corresponding physical quantity of AI1 minimum input	-100.0%~100.0%	0.0%	○	0502
P4.03	AI1 maximum analog input value	P4.01~11.00V	10.00V	○	0503
P4.04	Corresponding physical quantity of AI1 maximum input	-100.0%~100.0%	100.0%	○	0504
P4.05	AI1 input filter time constant	0.01~50.00s	0.05s	○	0505
S21R5GB, S22R2GB, 3R75GB/31R5PB and above:					
P4.06	Min analog value Input (AI2 Terminal)	0.00~P4.08	0.05V	○	0506
P4.07	Physical AI2 corresponding to Min analog value Input	-100.0%~100.0%	0.0%	○	0507
P4.08	Max analog value Input(AI2)	P4.06~11.00V	10.00V	○	0508
P4.09	Physical AI2 corresponding to Max analog value Input	-100.0%~100.0%	100.0%	○	0509
P4.10	Analog input filter time constant (AI2 Terminal)	0.01~50.00s	0.05s	○	050A
S2R4GB, S2R75GB:					
P4.06	Nonlinear analog input value 3	0.00~P4.08	0.00V	○	0506

Chapter 4 Parameter Index

Function code	Parameter	Setting range	Factory setting	Modify flag	Modbus address
P4.07	Corresponding physical quantity of nonlinear analog input value 3	-100.0%~100.0%	0.0%	○	0507
P4.08	Nonlinear analog input value 4	P4.06~10.00V	10.00V	○	0508
P4.09	Corresponding physical quantity of nonlinear analog input value 4	-100.0%~100.0%	100.0%	○	0509
P4.10	Reserve	-	-	*	050A
P4.11	Minimum pulse input value	0.00~P4.13	0.00kHz	○	050B
P4.12	Corresponding physical quantity of minimum pulse input value	-100.0%~100.0%	0.0%	○	050C
P4.13	Maximum pulse input value	P4.11~50.00kHz	50.00kHz	○	050D
P4.14	Corresponding physical quantity of maximum pulse input value	-100.0%~100.0%	100.0%	○	050E
P4.15	Reserve	-	-	*	050F
P4.16	Reserve	-	-	*	0510
P4.17	Reserve	-	-	*	0511
P4.18	Reserve	-	-	*	0512
P4.19	Reserve	-	-	*	0513
P4.20	Reserve	-	-	*	0514

Function code	Parameter	Setting range	Factory setting	Modify flag	Modbus address
P4.21	AO1 function definition	0: NULL 1: Output current (0 ~ 2 times of rated current of the inverter) 2: Output voltage (0 ~ maximum voltage) 3: PID setting (0 ~ 10V) 4: PID feedback (0 ~ 10V) 5: Calibration signal (5V) 6: Output torque (0 ~ 2 times of the rated torque of the motor) 7: Output power (0 ~ 2 times of the rated power of the inverter) 8: Bus voltage (0 ~ 1000V) 9: AI1 (0~10V/0~20mA) 10: AI2: 0~10V(S2R4GB and S2R75GB do not have AI2) 11: Reserve 12: Output frequency before compensation (0 ~ maximum frequency) 13: Output frequency after compensation (0 ~ maximum frequency) 14: Running speed (0 ~ 2 times of the rated speed)	0	×	0515
P4.22	Reserve	-	-	*	0516
P4.23	Reserve	-	-	*	0517
P4.24	DO output	0~ 14, the same as P4.21.	0	×	0518
P4.25	AO1 output range selection	0: 0~10V/0~20mA 1: 2~10V/4~20mA	0	○	0519
P4.26	Reserve	-	-	*	051A
P4.27	Reserve	-	-	*	051B
P4.28	AO1 Gain	-10.00~10.00	1.00	○	051C
P4.29	Reserve	-	-	*	051D
P4.30	Reserve	-	-	*	051E
P4.31	AO1 offset	-100.0%~100.0%	0.0%	○	051F
P4.32	Reserve	-	-	*	0520

Chapter 4 Parameter Index

Function code	Parameter	Setting range	Factory setting	Modify flag	Modbus address
P4.33	Reserve	-	-	*	0521
P4.34	DO maximum output frequency	DO minimum output frequency ~50.00KHz	10.00 KHz	○	0522
P4.35	DO minimum output frequency	0, 0.08 KHz ~ DO maximum output frequency	0.00KHz	○	0523

P5: PLC Run

Function code	Parameter	Setting range	Factory setting	Modify flag	Modbus address
P5.00	PLC operating mode	0: Single cycle 1 1: Single cycle 2 (keeping the final value) 2: Continuous cycle	2	×	0600
P5.01	PLC restarting mode selection	0: Start running from the first step 1: Continue to run at the step frequency at the moment of interrupt 2: Continue to run at the operation frequency at the moment of interrupt	0	×	0601
P5.02	PLC power failure record selection	0: Not save 1: Save Program running records will be automatically cleared when the parameter is set to 0	0	×	0602
P5.03	PLC operating time unit selection	0: sec 1: min	0	×	0603
P5.04	PLC operating timing T1	0.1~3600	10.0	○	0604
P5.05	PLC operating timing T2	0.0~3600	10.0	○	0605
P5.06	PLC operating timing T3		10.0	○	0606
P5.07	PLC operating timing T4		10.0	○	0607

Function code	Parameter	Setting range	Factory setting	Modify flag	Modbus address
P5.08	PLC operating timing T5	0.0~3600	10.0	○	0608
P5.09	PLC operating timing T6		10.0	○	0609
P5.10	PLC operating timing T7		10.0	○	060A
P5.11	PLC operating timing T8		10.0	○	060B
P5.12	PLC operating timing T9		10.0	○	060C
P5.13	PLC operating timing T10		10.0	○	060D
P5.14	PLC operating timing T11		10.0	○	060E
P5.15	PLC operating timing T12		10.0	○	060F
P5.16	PLC operating timing T13		10.0	○	0610
P5.17	PLC operating timing T14		10.0	○	0611
P5.18	PLC operating timing T15		10.0	○	0612
P5.19	Step T1 operating setting of PLC	1 F/r ~ 4 F/r	1F	○	0613
P5.20	Step T2 operating setting of PLC		1F	○	0614
P5.21	Step T3 operating setting of PLC		1F	○	0615
P5.22	Step T4 operating setting of PLC		1F	○	0616
P5.23	Step T5 operating setting of PLC		1F	○	0617
P5.24	Step T6 operating setting of PLC		1F	○	0618

Chapter 4 Parameter Index

Function code	Parameter	Setting range	Factory setting	Modify flag	Modbus address
P5.25	Step T7 operating setting of PLC	1 F/r ~ 4 F/r	1F	○	0619
P5.26	Step T8 operating setting of PLC		1F	○	061A
P5.27	Step T9 operating setting of PLC		1F	○	061B
P5.28	Step T10 operating setting of PLC		1F	○	061C
P5.29	Step T11 operating setting of PLC		1F	○	061D
P5.30	Step T12 operating setting of PLC		1F	○	061E
P5.31	Step T13 operating setting of PLC		1F	○	061F
P5.32	Step T14 operating setting of PLC		1F	○	0620
P5.33	Step T15 operating setting of PLC		1F	○	0621
P5.34	PLC operating record clearing		0: Not clear 1: Clear P5.34 Automatically recovers to 0 after clearing	0	×
P5.35	PLC operating steps record	0~15	0	*	0623
P5.36	Operating time of current step	0.0~3600	0.0	*	0624

P7: PID Control

Function code	Parameter	Setting range	Factory setting	Modify flag	Modbus address
P7.00	PID setting source 1	0: PID digital setting 1: AI1 terminal 2: AI2 terminal (S2R4GB and S2R75GB do not have AI2) 3: Reserve 4: Pulse input 5: Serial communication	0	×	0800
P7.01	PID setting source 2	0~ 5: ditto.	0	×	0801
P7.02	Combination of PID setting	0: PID setting by source 1 only 1: PID setting by source 2 only 2: Min (PID setting by source 1, PID setting by source 2) 3: Max (PID setting by source 1, PID setting by source 2) 4: PID setting by source 1 + PID setting by source 2 5: PID setting by source 1 - PID setting by source 2 6: PID setting by source 1 * PID setting by source 2 7: PID setting by source 1 / PID setting by source 2	0	×	0802
P7.03	PID feedback source 1	0: Built-in PG or single-phase speed measurement input 1: AI1 terminal 2: AI2 terminal (S2R4GB and S2R75GB do not have AI2) 3: Reserve 4: Pulse input 5: Serial communication	0	×	0803

Chapter 4 Parameter Index

Function code	Parameter	Setting range	Factory setting	Modify flag	Modbus address
P7.04	PID feedback source 2	0: Reserve 1~ 5: ditto.	0	×	0804
P7.05	Combination of PID feedback	0: PID feedback by source 1 only 1: PID feedback by source 2 only 2: MIN (PID feedback by source 1, PID feedback by source 2) 3: MAX (PID feedback by source 1, PID feedback by source 2) 4: PID feedback by source 1 + PID feedback by source 2 5: PID feedback by source 1 - PID feedback by source 2	0	×	0805
P7.06	Analog PID digital setting	-1000.0~1000.0, subject to limitation of analog PID setting range	0.0	○	0806
P7.07	Analog PID setting range	1.0~1000.0	100.0	○	0807
P7.08	Speed PID digital setting	0~24000rpm	0rpm	○	0808
P7.09	Proportional gain 1	0.1~30.0	1.0	○	0809
P7.10	PID integral time 1	0.00~100.0s	3.00s	○	080A
P7.11	PID derivative time 1	0.00~1.00s	0.00s	○	080B
P7.12	Switching frequency 1	0.00 ~ switching frequency 2	5.00Hz	○	080C
P7.13	Proportional gain 2	0.1~30.0	1.0	○	080D
P7.14	PID integral time 2	0.00~100.0s	3.00s	○	080E
P7.15	PID derivative time 2	0.00~1.00s	0.00s	○	080F

Function code	Parameter	Setting range	Factory setting	Modify flag	Modbus address
P7.16	Switching frequency 2	Switching frequency 1 ~ maximum frequency	20.00Hz	○	0810
P7.17	Differential object selection	0: Feedback differentiation 1: Deviation differentiation	0	×	0811
P7.18	PID integral amplitude limit	0.0%~100.0% Maximum output frequency is 100%	20.0%	○	0812
P7.19	PID differentiation amplitude limit	0.0%~100.0% Maximum output frequency is 100%	5.0%	○	0813
P7.20	PID output amplitude limit	0.0%~100.0% Maximum output frequency is 100%	100.0%	○	0814
P7.21	PID delay time constant	0.00~25.00s	0.00s	○	0815
P7.22	Error margin	0.0~999.9	0.0	○	0816
P7.23	PID adjustment characteristics	0: Positive action 1: Negative action	0	×	0817
P7.24	Integral adjustment selection	0: Stop integral control when the frequency reaches the upper and lower limit 1: Continue integral control when the frequency reaches the upper and lower limit	0	×	0818
P7.25	Sleep selection	0: Disable 1: Enable	0	×	0819
P7.26	Sleep delay	0~999s	120s	○	081A
P7.27	Sleep threshold	0~upper limit frequency	20.00Hz	○	081B
P7.28	Wake-up threshold	0.0~999.9	3.0	○	081C
P7.29	PID Feed forward coefficient	0.500~1.024	1.000	○	081D

Chapter 4 Parameter Index

Function code	Parameter	Setting range	Factory setting	Modify flag	Modbus address
P7.30	Selection of KP processing mode and slow start mode within deviation range	Unit's: 0-not process KP within deviation range 1- Dynamic KP within deviation range 2- fixed KP within deviation range Ten's: 0-not use slow start function 1-use slow start 1 2- use slow start 2	00	○	081E
P7.31	KP low limit	0.01 ~ 2.55	0.06	○	081F
P7.32	slow start mode KP value	0.01 ~ 30.00	0.10	○	0820
P7.33	slow start hold time	0.01 ~ 999.9s	10.0s	○	0821

P8: Vector Control Parameters

Notes: S2R4GB or S2R75GB has no SVC, parameters of “Group P8” can't be changed.

Function code	Parameter	Setting range	Factory setting	Modify flag	Modbus address
P8.00	Pre-excitation current compensation amount	0.0~500.0% 100.0% corresponds to the motor no-load current; the response time is set in P1.04 The actual upper limit is the smaller one between inverter 80% rated current and motor rated current.	100.0%	○	0900
P8.01	Speed loop proportional gain 1	0.1~30.0	2.0	○	0901
P8.02	Speed loop integral time 1	0.001~10.00s	Depend on model	○	0902
P8.03	Speed loop switching frequency 1	0.00Hz ~ speed loop switching frequency 2	10.00Hz	○	0903

Function code	Parameter	Setting range	Factory setting	Modify flag	Modbus address
P8.04	Speed loop proportional gain 2	0.1~30.0	1.0	○	0904
P8.05	Speed loop integral time 2	0.001~10.00s	Depend on model	○	0905
P8.06	Speed loop switching frequency 2	Speed loop switching frequency 1 ~ maximum frequency	80.00Hz	○	0906
P8.07	Speed loop filter time	0.000s~0.100s	0.030s	○	0907
P8.08	Speed loop filter time estimation	1.0~20.0ms	1.0	○	0908
P8.09	Feedforward coefficient of speed loop	0.500~1.024	1.000	×	0909
P8.10	Torque control mode	0: Run in speed control mode 1: Run in torque control mode 2: Run in torque motor mode	0	○	090A
P8.11	Driving torque setting source	0: Digital setting 1: AI1 2: AI2 (S2R4GB and S2R75GB do not have AI2) 3: Reserve 4: Pulse input 5: Serial communication	0	×	090B
P8.12	Upper limit of driving torque	G type: 0.0%~200.0% P type: 0.0%~150.0%	G: 160.0% P: 130.0%	○	090C
P8.13	Upper limit of braking torque	G type: 0.0%~200.0% P type: 0.0%~150.0%	G: 160.0% P: 130.0%	○	090D
P8.14	Command slip compensation Factor	0.0%~200.0%	102.4%	○	090E

Chapter 4 Parameter Index

Function code	Parameter	Setting range	Factory setting	Modify flag	Modbus address
P8.15	Torque acceleration time	0.00~120.0s	0.50s	○	090F
P8.16	Torque deceleration time	0.00~120.0s	0.50s	○	0910
P8.17	Estimated low speed slip compensation	50.0%~200.0%	130.0%	○	0911
P8.18	Estimated high speed slip compensation	50.0%~200.0%	117.0%	○	0912
P8.19	Reserve	-	-	○	0913
P8.20	Reserve	-	-	○	0914
P8.21	Reserve	-	-	○	0915
P8.22	Reserve	-	-	○	0916
P8.23	Zero speed torque boosting	0.0~50.0%	0.0%	○	0917
P8.24	Zero speed threshold	0~20% (maximum frequency)	5%	○	0918
P8.25	Braking torque setting source	0: Same as final driving torque value calculated in P8.11 1: AI1 2: AI2(S2R4GB and S2R75GB do not have AI2) 3: Reserve 4: Pulse input 5: Serial communication	0	×	0919
P8.26	High-speed torque supplement	40.0%~160.0%	100.0%	○	091A
P8.27	High-speed torque supplement reference	0: the operating frequency 1: the line speed (reserve) 2: the load inertia	0	○	091B
P8.28	Pre-excitation time	0.05~3.00s	0.10s	○	091C

P9: V / F Control Parameter

Function code	Parameter	Setting range	Factory setting	Modify flag	Modbus address
P9.00	V/F curve setup	0: Constant torque characteristic curve 0 1: Variable torque characteristic curve 1 (2.0) 2: Variable torque characteristic curve 2 (1.5) 3: Lower torque characteristic curve 3 (1.2) 4: User defined V / F curve(determined by P9.01 ~ P9.06 function code)	0	×	0A00
P9.01	V/F frequency F1	0.0~P9.03	10.00Hz	×	0A01
P9.02	V/F voltage V1	0.0~100.0%	20.0%	×	0A02
P9.03	V/F frequency F2	P9.01~P9.05	25.00Hz	×	0A03
P9.04	V/F voltage V2	0.0~100.0%	50.0%	×	0A04
P9.05	V/F frequency F3	P9.03~P0.09	40.00Hz	×	0A05
P9.06	V/F voltage V3	0~100.0%	80.0%	×	0A06
P9.07	Torque boost	0.0: Automatic torque boost 0.1~30.0%: Manual boost	0.0%	○	0A07
P9.08	Cutoff frequency of manual torque boost	0.00~50.00Hz	16.67Hz	○	0A08
P9.09	Slip compensation coefficient	0.0~250.0% (rated torque is 100%)	0.0%	○	0A09
P9.10	Slip compensation time constant	0.01~2.55s	0.20s	○	0A0A

Chapter 4 Parameter Index

Function code	Parameter	Setting range	Factory setting	Modify flag	Modbus address
P9.11	Energy efficient control selection	0: Energy efficient control is disabled 1: Energy efficient control is enabled	0	×	0A0B
P9.12	Energy efficient gain coefficient	0.00~655.3	Depend on model	×	0A0C
P9.13	Energy efficient voltage lower limit (50Hz)	0~120%	50%	×	0A0D
P9.14	Energy efficient voltage lower limit (5Hz)	0~25%	12%	×	0A0E
P9.15	Average power time	(1~200) * (25ms)	5	×	0A0F
P9.16	AVR function	0: Inactive 1: Always Enabled 2: Inactive only during deceleration	2	×	0A10
P9.17	Over modulation selection	0: Invalid 1: Valid	0	×	0A11
P9.18	Droop control (load distribution)	0.00~10.00Hz	0.00Hz	○	0A12
P9.19	Output voltage offset source	0: Digital setting 1: AI1 2: AI2 (S2R4GB and S2R75GB do not have AI2) 3: Reserve 4: Pulse input 5: Communication setting Maximum output voltage is 100% Valid only in V / F separation mode	0	×	0A13
P9.20	Output voltage offset	0.0%~100.0%	0.0%	○	0A14

Function code	Parameter	Setting range	Factory setting	Modify flag	Modbus address
P9.21	Oscillation suppression coefficient	0~100	0	○	0A15

PA: Motor Parameters

Function code	Parameter	Setting range	Factory setting	Modify flag	Modbus address
PA.00	Motor selection	0: Use motor 1 1: Use motor 2	0	×	0B00
PA.01	Pole number of motor 1	2~56	4	×	0B01
PA.02	Rated power of motor 1	0.4~999.9kW	Depend on model	×	0B02
PA.03	Rated speed of motor 1	0~24000r/min		○	0B03
PA.04	Rated current of motor 1	0.1~999.9A		×	0B04
PA.05	No-load current I0 of motor 1	0.1~999.9A		×	0B05
PA.06	Stator resistance R1 of motor 1	0.001~65.000Ω		○	0B06
PA.07	Leakage inductance L1 of motor 1	0.1~2000.0mH		○	0B07
PA.08	Rotor resistance R2 of motor 1	0.001~65.000Ω		○	0B08
PA.09	Mutual inductance resistance Lm of motor 1	0.1~2000.0mH		○	0B09
PA.10	Magnetic saturation coefficient 1 of motor 1	0.0%~100.0%		○	0B0A
PA.11	Magnetic saturation coefficient 2 of motor 1	0.0%~100.0%		○	0B0B

Chapter 4 Parameter Index

Function code	Parameter	Setting range	Factory setting	Modify flag	Modbus address
PA.12	Magnetic saturation coefficient 3 of motor 1	0.0%~100.0%	Depend on model	○	0B0C
PA.13	Magnetic saturation coefficient 4 of motor 1	0.0%~100.0%		○	0C0D
PA.14	Magnetic saturation coefficient 5 of motor 1	0.0%~100.0%		○	0B0E
PA.15	Pole Number of motor 2	2~56	4	×	0B0F
PA.16	Rated power of motor 2	0.4~999.9kW	Depend on model	×	0B10
PA.17	Rated speed of motor 2	0~24000r/min		○	0B11
PA.18	Rated current of motor 2	0.1~999.9A		×	0B12
PA.19	No-load current I0 of motor 2	0.1~999.9A		×	0B13
PA.20	Stator resistance R1 of motor 2	0.001~65.000Ω		○	0B14
PA.21	leakage inductance L1 of motor 2	0.1~2000.0mH		○	0B15
PA.22	Rotor resistance R2 of motor 2	0.001~65.000Ω		○	0B16
PA.23	Mutual inductance resistance Lm of motor 2	0.1~2000.0mH		○	0B17
PA.24	Magnetic saturation coefficient 1 of motor 2	0.0%~100.0%		○	0B18

Function code	Parameter	Setting range	Factory setting	Modify flag	Modbus address
PA.25	Magnetic saturation coefficient 2 of motor 2	0.0%~100.0%	Depend on model	○	0B19
PA.26	Magnetic saturation coefficient 3 of motor 2	0.0%~100.0%		○	0B1A
PA.27	Magnetic saturation coefficient 4 of motor 2	0.0%~100.0%		○	0B1B
PA.28	Magnetic saturation coefficient 5 of motor 2	0.0%~100.0%		○	0B1C
PA.29	Motor parameter tuning (reserve in S2R4GB or S2R75GB)	0: No operation 1: Static parameter tuning 2: Rotating parameter tuning	0	×	0B1D
PA.30	Parameter tuning process information	-	-	*	0B1E

Pb: MODBUS Communication

Function code	Parameter	Setting range	Factory setting	Modify flag	Modbus address
Pb.00	Baud rate selection	0: 1200bps 1: 2400bps 2: 4800bps 3: 9600 bps 4: 19200bps 5: 38400bps	3	×	0C00
Pb.01	Local address	0~31	1	×	0C01
Pb.02	Communication data format	0: 1-8-1-E, RTU 1: 1-8-1-O, RTU 2: 1-8-1-N, RTU 3: 1-7-1-E, ASCII 4: 1-7-1-O, ASCII 5: 1-7-2-N, ASCII 6: 1-8-1-E, ASCII 7: 1-8-1-O, ASCII 8: 1-8-2-N, ASCII Note: 3~8 reserve	0	×	0C02

Chapter 4 Parameter Index

Function code	Parameter	Setting range	Factory setting	Modify flag	Modbus address
Pb.03	Communication timeout detection time	0.0~100.0s 0: No timeout detection Other: Timeout detection time	0.0s	○	0C03
Pb.04	Response delay time	0~500ms	5ms	×	0C04
Pb.05	Reserve	-	-	×	0C05
Pb.06	EEPROM save selection	0: Not directly save to EEPROM 1: Directly save to EEPROM	0	×	0C06
Pb.07	CCF6 fault handling	0: Resume without reporting failure 1: Report failure and stop automatically	0	×	0C07
Pb.08	Response control	0: Normal response 1: no response when writing instruction	0	○	0C08

PC: Display control

Function code	Parameter	Setting range	Factory setting	Modify flag	Modbus address
PC.00	Reserve	-	-	*	0D00
PC.01	Output frequency (Hz) (Before compensation)	0: Not displayed 1: Displayed	1	○	0D01
PC.02	Output frequency (Hz) (Actual)	0: Not displayed 1: Displayed	0	○	0D02
PC.03	Output current (A)	0: Not displayed 1: Displayed	1	○	0D03
PC.04	Setting frequency (Hz, flicker)	0: Not displayed 1: Displayed	1	○	0D04
PC.05	Operating speed (r/min)	0: Not displayed 1: Displayed	1	○	0D05
PC.06	Setting speed (R/min, flicker)	0: Not displayed 1: Displayed	0	○	0D06

Function code	Parameter	Setting range	Factory setting	Modify flag	Modbus address
PC.07	Operating linear speed (m/s)	0: Not displayed 1: Displayed	0	○	0D07
PC.08	Setting linear speed (m/s, flicker)	0: Not displayed 1: Displayed	0	○	0D08
PC.09	Output power (kW)	0: Not displayed 1: Displayed	0	○	0D09
PC.10	Output torque (%)	0: Not displayed 1: Displayed	0	○	0D0A
PC.11	Output voltage (V)	0: Not displayed 1: Displayed	1	○	0D0B
PC.12	Bus voltage (V)	0: Not displayed 1: Displayed	0	○	0D0C
PC.13	AI1 (V)	0: Not displayed 1: Displayed	0	○	0D0D
PC.14	AI2(V) (S2R4GB and S2R75GB do not have AI2)	0: Not displayed 1: Displayed	0	○	0D0E
PC.15	Reserve	-	-	*	0D0F
PC.16	Analog PID feedback (%)	0: Not displayed 1: Displayed	0	○	0D10
PC.17	Analog PID feeding (% , flicker)	0: Not displayed 1: Displayed	0	○	0D11
PC.18	External count value	0: Not displayed 1: Displayed	0	○	0D12
PC.19	Terminal status (No unit)	0: Not displayed 1: Displayed	0	○	0D13
PC.20	Reserve	-	-	*	0D14
PC.21	Power on display selection	1~20	1	○	0D15

Chapter 4 Parameter Index

Function code	Parameter	Setting range	Factory setting	Modify flag	Modbus address
PC.22	Speed display coefficient	0.1~999.9% Mechanical speed = measured speed * PC.22 (PG) Mechanical speed = 120 * operating frequency / motor poles * PC.22 (non-PG) Set speed = PID set speed * PC.22 (PG) Set speed = 120 * setting frequency / motor poles * PC.22 (non-PG) Notes: Have no effect on actual speed	100.0%	○	0D16
PC.23	Linear speed coefficient	0.1~999.9% Linear speed = operating frequency * PC.23 (non-PG) Linear speed = mechanical speed * PC.23 (PG) Set linear speed = setting frequency * PC.23 (non-PG) Set linear speed = set speed * PC.23 (PG) Notes: Have no effect on actual speed	100.0%	○	0D17

Pd: Protection and Fault Parameters

Function code	Parameter	Setting range	Factory setting	Modify flag	Modbus address
Pd.00	Motor overload protection mode selection	0: No protection 1: Common motor (with low speed compensation) 2: Variable frequency motor (without low speed compensation) 3: Sensor protection (immediate protection once over threshold)	1	×	0E00

Function code	Parameter	Setting range	Factory setting	Modify flag	Modbus address
Pd.01	Protection threshold of motor 1	0.0~10.0V	10.0V	×	0E01
Pd.02	Protection sensor input channel of motor 1	0: Terminal AI1 1: Terminal AI2 (S2R4GB and S2R75GB do not have AI2) 2: Reserve 3: Pulse input 4: Communication setting	0	×	0E02
Pd.03	Protection threshold of motor 2	0.0~10.0V	10.0V	×	0E03
Pd.04	Protection sensor input channel of motor 2	0: Terminal AI1 1: Terminal AI2 (S2R4GB and S2R75GB do not have AI2)) 2: Reserve 3: Pulse input 4: Communication setting	0	×	0E04
Pd.05	Electronic thermal relay protection value	20~110%	100%	○	0E05
Pd.06	Overload pre-alarm detection level	20.0~200.0%	160.0%	×	0E06
Pd.07	Overload pre-alarm detection time	0.0~60.0s	60.0s	×	0E07
Pd.08	Current amplitude limit	0: Invalid 1: Valid during acceleration and deceleration, and invalid during constant speed operation 2: Valid all the time 3: Decrease operating speed during over current	1	○	0E08

Chapter 4 Parameter Index

Function code	Parameter	Setting range	Factory setting	Modify flag	Modbus address
Pd.09	Current amplitude limit level	G type: 30~180% P type: 60~140%	G: 160% P: 120%	○	0E09
Pd.10	Overvoltage stall selection	0: Prohibited (The proposed option, when braking resistor is mounted) 1: Allowed	1	×	0E0A
Pd.11	Overvoltage stall point	110.0 ~ 150.0% of the bus voltage	220V models: 120% 380V models: 140%	×	0E0B
Pd.12	Input phase loss detection benchmark	1~100%	100%	×	0E0C
Pd.13	Input phase loss detection time	2~255s	10s	×	0E0D
Pd.14	Output phase loss detection benchmark (reserve in S2R4GB and S2R75GB)	0~100%	1%	×	0E0E
Pd.15	Output phase loss detection time (reserve in S2R4GB and S2R75GB)	0.0~20.0s	2.0s	×	0E0F
Pd.16	Reserve	-	-	*	0E10
Pd.17	AE1 alarm selection	0: Do not display warning 1: Display warning	0	×	0E11
Pd.18	Automatic reset times	0~10, 0 indicates no automatic reset Only three failures have automatic reset function	0	×	0E12
Pd.19	Reset interval time	2.0~20.0s	5.0s	×	0E13

Function code	Parameter	Setting range	Factory setting	Modify flag	Modbus address
Pd.20	Confirm time before over-current deceleration	0~200ms	50ms	×	0E14
Pd.21	Operation protection when power on	0: No protection 1: Protection	0	○	0E15
Pd.22	Operation protection after control command set channel switching	0: Continue to run 1: Stop, restart after receive new run command	0	×	0E16
Pd.23	Reserve	-	-	×	0E17
Pd.24	Reserve	-	-	×	0E18
Pd.25	Reserve	-	-	○	0E19
Pd.26	Reserve	-	-	○	0E1A
Pd.27	Reserve	-	-	○	0E1B
Pd.28	Reserve	-	-	○	0E1C
Pd.29	Reserve	-	-	○	0E1D
Pd.30	Reserve	-	-	○	0E1E
Pd.31	Reserve	-	-	○	0E1F
Pd.32	Reserve	-	-	○	0E20
Pd.33	Software current limit point(reserve in S2R4GB and S2R75GB)	100.0%~300.0%	Depend on model	○	0E21
Pd.34	Hardware current limit Enabled (reserve in S2R4GB and S2R75GB)	0: Prohibited 1: Allowed	1	○	0E22

Chapter 4 Parameter Index

Function code	Parameter	Setting range	Factory setting	Modify flag	Modbus address
Pd.35	Input phase loss detection by hardware (3030G/3037P and below do not have this function)	0: Prohibited 1: Allowed	1	×	0E23

PE: Run History Record

Function code	Parameter	Setting range	Factory setting	Modify flag	Modbus address
PE.00	Displayed fault selection	0~30	1	○	0F00
PE.01	Type of fault	0: NULL 1: Uu1 bus under-voltage 2: Uu2 control circuit under-voltage 3: Uu3 poor charging circuit 4: OC1 acceleration overcurrent 5: OC2 deceleration overcurrent 6: OC3 constant speed overcurrent 7: Ou1 acceleration overvoltage 8: Ou2 deceleration overvoltage 9: Ou3 constant speed overvoltage 10: GF Ground 11: OH1 radiator overheat 12: OL1 motor overload 13: OL2 inverter overload 14: SC load short circuit 15: EF0 external fault from an serial communication 16: EF1 external fault on terminals	NULL	*	0F01

Function code	Parameter	Setting range	Factory setting	Modify flag	Modbus address
PE.01	Type of fault	(Contd.) 17: SP1 input phase loss or imbalance 18: SPO output phase loss or imbalance 19: CCF1 control loop fault 1. The transmission between the inverter and the keypad still cannot be established 5s after powering on 20: CCF2 control loop fault 2. After connecting the inverter and the keypad, the transmission failure last for more than 2 seconds 21: CCF3 EEPROM failure 22: CCF4 AD translation exception 23: CCF5 RAM failure 24: CCF6 CPU is disturbed 25: PCE Parameter name replication error 26: Reserve 27: HE Hall current detection fault 28: De Cut-to-length detection fault 29: Cue Feed off fault 30: OH3 Rectifier bridge overheat	NULL	*	0F01
PE.02	Output frequency at fault	0~upper limit frequency			
PE.03	Setting frequency at fault	0~upper limit frequency	0.00Hz	*	0F03
PE.04	Output current at fault	0 ~ 2 times of the rated current	0.0A	*	0F04

Chapter 4 Parameter Index

Function code	Parameter	Setting range	Factory setting	Modify flag	Modbus address
PE.05	Bus voltage at fault	0~1000V	0V	*	0F05
PE.06	Service condition at fault	0: StP Stop 1: Acc Acceleration 2: dEc deceleration 3: con Constant speed	StP	*	0F06
PE.07	Total power-on time at fault	0~65530h	0h	*	0F07
PE.08	IGBT temperature at fault	0.0~200.0°C	0.0°C	*	0F08
PE.09	Reserve	-	-	*	0F09
PE.10	Total operation time	0~65530h	0h	*	0F0A
PE.11	Total power-on time	0~65530h	0h	*	0F0B
PE.12	Total electricity consumption (MWh)	0~9999MWh	0MWh	*	0F0C
PE.13	Total electricity consumption (KWh)	0~999KWh	0KWh	*	0F0D
PE.14	IGBT temperature	0.0~200.0°C	0.0°C	*	0F0E
PE.15	Rectifier bridge temperature	0.0~200.0°C	0.0°C	*	0F0F

PF: Parameter Protection and Product Identification Information

Function code	Parameter	Setting range	Factory setting	Modify flag	Modbus address
PF.00	User password	0: No password Other: Password protection	0	○	1000

Function code	Parameter	Setting range	Factory setting	Modify flag	Modbus address
PF.01	Parameter write protection	0: All parameters are allowed to be rewritten 1: Except for setting frequency (P0.02), and this function code(PF.01), the other function codes are prohibited to be rewritten 2: Except for this function code, all others are prohibited to be rewritten	0	○	1001
PF.02	Parameter Initialization	0: No operation 1: Clear the fault record 2: Restore factory settings (Except the record / password / motor parameters) 3: Restore factory settings (Except the record/ password)	0	×	1002
PF.03	Parameters copy	0: No action 1: Download parameters 2: Upload parameters 3: Download parameters except motor's Note: Only be used to the optional keypad.	0	×	1003
PF.04	G/P select	0: Type G (Constant torque) 1: Type P (Variable torque like fan and pump series loads)	0	×	1004
PF.05	Application select	0: General inverter 1: Rotary cutting machine	0	×	1005
PF.06	Reserve	-	-	*	1006
PF.07	Reserve	-	-	*	1007
PF.08	Reserve	-	-	*	1008

Chapter 4 Parameter Index

Function code	Parameter	Setting range	Factory setting	Modify flag	Modbus address
PF.09	Product serial number	0~9999		*	1009
PF.10	Software version number	0.00~99.99		*	100A
PF.11	Non-standard version and serial number	0.000~9.999		*	100B
PF.12	Software identification code	0~9999		*	100C

Chapter 5 Detailed Function Introductions

5.1 Basic Function (Group P0)

P0.00 Menu display mode	Setting range: 0~1 [0]
-------------------------	------------------------

0: Standard menu

1: Check mode menu

Notes:

- ◆ When P0.00 is set to 1, the display enters the check menu mode. In this mode, you can view and modify each modified function code by the knob adjustment. The remaining unmodified function codes will not be displayed unless you change the setting to 0 again.

P0.01 Control mode	Setting range: 0~3 [0]
--------------------	------------------------

0: V/F control

1: Reserve

2: Sensor-less vector control (SVC)

3: V/F separation control

Notes:

- ◆ V / F control: Please select this control mode when using one inverter to drive more than one motor, or the motors' parameters cannot be automatically tuned nor obtained by other method.
- ◆ Sensor-less vector control: This mode doesn't need a speed sensor. It can be used in ordinary high-performance variable speed applications. (S2R4GB or S2R75GB: no SVC)
- ◆ V/F separation control: This control mode can be used in some places where the frequency and the voltage are required to control independently.

Tips:

When selecting sensor-less vector control mode, if the motor is not default ordinary 4-pole asynchronous motor, it is required to correctly set the nameplate parameters of the motor first, and carry out motor parameters self-tuning to obtain accurate parameters of motor. To obtain the best control performance, it is suggested to carry out motor nameplate parameters setting and self-tuning of motor parameters before the initial running; besides, it is needed to set the relevant parameters of vector control correctly. Please see description of Group P8 vector control parameters for details.

Note that in this control mode, usually, one inverter motor can only control one motor, and the power rating of the inverter should not be too different from that of the motor, power rating of the motor can be one class bigger or smaller than that of the inverter, otherwise it will result in poor control performance or improper running.

P0.02 Frequency digital setting	Setting range: 0.00Hz ~Maximum frequency [0.00Hz]
---------------------------------	---

Notes:

- ◆ When the function code P0.03 or P0.04 = 1, this function code is enabled when setting frequency digital setting with a keypad. It defines the frequency setting

value of the inverter.

Tips:

The changed value of P0.02 by keypad digital encoder will be active immediately. If press "ENTER" key, the value will be stored into the inverter's internal EEPROM and will not be lost even power-off the inverter.

When P0.03 is set to 1: if P3.18 is set to 2, the changed value of P0.02 by keypad digital encoder will be saved when power loss. Otherwise, the changed value will not be saved

P0.03 Frequency setting source 1	Setting range: 0~11 [1]
0: NULL	1: Frequency digital setting, digital knob adjustment
2: Terminal AI1	3: Terminal AI2 (S2R4GB and S2R75GB do not have AI2)
4: Reserve	5: Pulse input
6: Serial communication	7: Reserve
8: Multi-step Speed	9: Terminal UP/DOWN
10: Programmable Logic Controller (PLC)	11: PID close-loop

P0.04 Frequency setting source 2	Setting range: : 0~9 [0]
0: NULL	1: Frequency digital setting, digital knob adjustment
2: Terminal AI1	3: Terminal AI2 (S2R4GB and S2R75GB do not have AI2)
4: Reserve	5: Pulse input
6: Serial communication	7: Reserve
8: Multi-step Speed	9: torque deviation compensation amount

Notes:

- ◆ If P0.03 is set to 1: During keypad digital setting, in monitoring state, the setting frequency can be modified through digital knob on the keypad; when the setting frequency is related to P0.02, in monitoring state, value of P0.02 can be adjusted through the keypad knob.
- ◆ Terminal AI1, AI2 are analog input signals. When using terminal AI1, AI2, the output frequency can be adjusted through 0~10V voltage signal or 0~20mA current signal. Signal type is selected through the relevant DIP switch on the control circuit board, and please refer to Wiring Instruction for Control Loop in Section 2.4.
- ◆ Corresponding relationship between amplitude of input signals, include those of terminal AI1, AI2 and pulse input, and frequencies is programmable. Please see detailed descriptions of Group P4 parameters.
- ◆ Serial communication setting, the user can connect the serial communication port to a PC or PLC. In this way, the setting frequency of the inverter is controlled by the communication mode.
- ◆ When P0.03 is set to 9, see description of Group P3 UP/DOWN.

- ◆ When P0.04 is set to 9, compensation amount is half of the corresponding slip frequency for the difference of the set torque and the actual torque.

P0.05 Frequency setting combination 1	Setting range: 0~9 [0]
P0.06 Frequency setting combination 2	Setting range: 0~9 [0]
0: Frequency setting by source 1 only	1: Frequency setting by source 2 only
2: MIN(Frequency setting by source 1, Frequency setting by source 2)	3: MAX(Frequency setting by source 1, Frequency setting by source 2)
4: Frequency setting by source 1 + Frequency setting by source 2	5: Frequency setting by source 1-Frequency setting by source 2
6: Frequency setting by source 1 * Frequency setting by source 2	7: Frequency setting by source 1 / Frequency setting source 2
8: Frequency setting by source 1-Frequency setting by source 2	9: Frequency setting by source2 * (Maximum output frequency+frequency setting by source 1) / Maximum output frequency

Notes:

- ◆ Frequency setting by source 1: It represents the frequency setting based on P0.03 frequency setting source 1.
- ◆ Frequency setting by source 2: It represents the frequency setting based on P 0.04 frequency setting source 2
- ◆ The final frequency is set by appropriate combination operation of frequency setting source 1 and the frequency setting source 2.
- ◆ If "FC" function terminal is defined (see P3.01~P3.11), and the terminal function is enabled, then the result of frequency setting combination 2 of P0.06 is actual setting frequency; if the "FC" function terminal is not defined, or it is defined, but the terminal function is disabled, then result of frequency setting combination 1 of P0.05 is the actual setting frequency. Users can switch at will between the two different frequency setting combinations. If the combination mode is 6 or 7, then the value set by frequency setting source 2 no longer represents frequency, instead it will be used as the coefficient with its absolute value.

P0.07 Control command set channel	Setting range: 0~5 [0]
0: Keypad control	1: Terminal control 1 (STOP invalid)
2: Terminal control 2 (STOP valid)	3: Serial communication 1 (STOP invalid)
4: Serial communication 2 (STOP valid)	5: Terminal control 3 (STOP and JOG invalid)

Notes:

- ◆ In keypad control mode, the user controls start and stop of the inverter directly through RUN, STOP keys on the keypad.
- ◆ In terminal control mode, the user needs to define multi-function input terminals first to realize the operation functions of RUN, F/R, FWD, REV, HLD, etc. (see P3.01~ P3.11), and then the terminals control the start and stop of the inverter.

- ◆ In serial communication control mode, the user connects the serial communication port to a PC or PLC. The start, stop, forward and reversed rotation of the inverter is controlled by the communication mode.
- ◆ When STOP key is enabled, the user can stop the inverter with the STOP key on the keypad, which is used in occasions of emergency stop. When STOP key is disabled, the user can only stop the inverter through the set control mode.
- ◆ When P0.07 is set to 5, JOG and STOP keys on the keypad are disabled; when JOG key is disabled, the JOG key on the keypad fails, the user can only enable inching running through terminal.
- ◆ In keypad and terminal control modes, the communication read/write parameter operations are ignored.

P0.08 Keypad direction setting	Setting range: 0, 1 [0]
0: Forward	1: Reverse

Notes:

- ◆ Pressing JOG key (P2.51=1) will switch the direction, and change the value of parameter P0.08. But the changed direction only takes effect currently.
- ◆ Only by changing value of parameter P0.08 and pressing “ENTER” to save the value, keypad direction setting will be saved permanently.
- ◆ Direction priority: Terminal setting is the highest, second is set by communication, keypad is the lowest. If the higher one is invalid, the lower priority will take effect.

P0.09 Basic frequency	Setting range: low frequency mode: 0.10 ~ 400.0Hz [50.00Hz] high frequency mode (reserve): 0.1 ~ 1000Hz [50.0Hz]
P0.10 Maximum output frequency	Setting range: low frequency mode: MAX [50.00Hz, upper limit frequency, setting frequency, Multi-step frequency, jump frequency] ~ 400.0Hz [50.00Hz] high frequency mode(reserve): MAX [50.0Hz, upper limit frequency, setting frequency, Multi-step frequency, jump frequency] ~ 1000Hz [50.0Hz]

Notes:

- ◆ Basic frequency F_{BASE} : The minimum output frequency when the output voltage of the inverter is equal to the rated voltage U_N . It is used as the benchmark of the regulating frequency. Usually, the rated frequency of the motor is used as the setting value of the fundamental frequency. In the usual case of the use, F_{BASE} is selected according to the rated frequency of the motor. In particular occasions of use, it can be set according to the operating requirement, but it should be noted to fit with V / F characteristic of the load motor and the output requirements of the motor, which is shown in Fig. 5-0-1 Relationship between output frequency and output voltage.

- ◆ Maximum frequency F_{MAX} is the maximum frequency of this series of inverter allowed to output. If the set point is greater than the rated value of the drive unit, it may result in damage to motor and mechanical equipment.

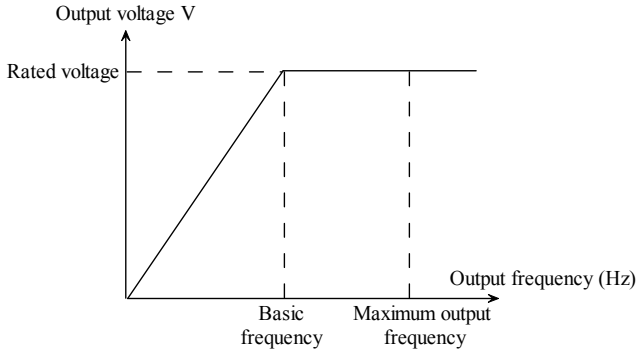

Fig. 5-0-1 Relationship between output frequency and output voltage

P0.11 Upper limit frequency setting source	Setting range: 0~5 [0]
0: Digital setting	1: Terminal AI1
2: Terminal AI2(S2R4GB and S2R75GB do not have AI2)	3: Reserve
4: Pulse input	5: Communication setting

Notes:

- ◆ In non-zero setting, adjustable range of the upper limit frequency is 0 ~ P0.12 upper limit frequency.

P0.12 Upper limit frequency setting	Setting range: MAX (lower limit frequency, jog frequency, UP/DN given amplitude, sleep threshold) ~ maximum frequency [50.00Hz]
P0.13 Offset of upper limit frequency	Setting range: 0.00~upper limit frequency [0.00Hz]
P0.14 Rated voltage of motor	Setting range: 60~480V [Rated voltage]
P0.15 Lower limit frequency	Setting range: 0.00~upper limit frequency [0.00Hz]
P0.16 Maximum output voltage	Setting range: 60~480V [Rated voltage]

Notes:

- ◆ Upper limit frequency is the highest frequency allowing forwarding rotation and reverse rotation of the inverter, lower limit frequency is the minimum frequency allowing running of the inverter. Set the upper limit frequency and lower limit frequency, and automatically ensure that the output frequency is not higher than the upper limit frequency, and not less than the lower limit frequency. This function is commonly used to ensure that the motor operates at the allowable frequency in order to avoid accidents of mechanical system or inverter caused by

mis-operation or unintended causes. It is particularly applicable to occasions preventing low-speed or over speed running (see P2.04).

- ◆ Upper limit frequency offset: When the upper limit frequency source is an analog setting, the parameter is used as the analog offset. Its benchmark is P0.12. Bias frequency is added to set point of upper limit frequency (P0.12) as the final upper limit frequency. When the upper limit frequency source is the digital setting, offset plus P0.12 is the final value of upper limit frequency.
- ◆ The maximum output voltage is the corresponding voltage when the inverter outputs fundamental frequency. It is usually the rated input voltage specified on the motor nameplate.

P0.17 Keypad knob adjusting rate	Setting range: 0~250 * (0.01Hz 1rpm) [0]
----------------------------------	--

Notes:

This parameter is only active for the online adjustment of frequency and speed setting in monitoring state;

- ◆ When the function code is set to 0, and the keypad knob is integral regulation mode, which means rotating the knob continuously and keeping the rotation speed can increase the adjustment step width gradually from 1 to 10, from 10 to 100, and up to 100 (maximum);
- ◆ When the function code is not set to 0, it is the fixed-step regulation mode. The set value is the corresponding variation of the set frequency or speed when rotating the knob for one position, which means the adjustment amount of set frequency or speed when rotating the knob for one round is $(P0.17 * 30) * (0.01\text{Hz or } 1\text{rpm})$.
- ◆ When the adjustment object is the frequency, the unit of P0.17 is 0.01Hz; when the adjustment object is the speed, in general operating mode, the unit of P0.17 is $(6 / (5 * \text{motor poles})) \text{ rpm}$, in digital PID mode, the unit of P0.17 is 1rpm;

Example:

In general operating mode, in the adjustable range of the frequency, when $P0.17 = 100$, if rotating the knob on the keypad for one circle, the set frequency increases or decreases 30.00Hz, the speed increases or decreases 900rpm; when $P0.17 = 10$, then the set frequency and the speed increase or decrease 3.00Hz and 90rpm respectively. In digital PID operation mode, when $P0.17 = 10$, the speed increases or decreases 300rpm while rotating the knob on the keypad for a circle;

P0.18 Acceleration time1	Setting range: 0.1~3600s [6.0s/20.0s]
P0.19 Deceleration time1	Setting range: 0.1~3600s [6.0s/20.0s]

Notes:

- ◆ Acceleration time: The time that the inverter speed rises from zero speed up to the maximum frequency. Deceleration time: The time that the inverter decelerates from the maximum frequency to zero speed.
- ◆ This series of inverter defines four groups acceleration and deceleration time (the others see P2.28 ~ P2.33), user can select different acceleration and deceleration time through external terminals according to the needs, or can select different acceleration and deceleration time during the PLC program timing run.

- ◆ The default unit of acceleration and deceleration time is second. The acceleration and deceleration time can be reduced or enlarged to 10 times by modifying P2.35 acceleration and deceleration time multiplying factor.

5.2 Start/Stop Control (Group P1)

P1.00 Starting mode	Setting range: 0~2 [0]
0: Start from the start-up frequency	1: First brake (excitation), and then start at the start-up frequency
2: Rotating speed tracking (Flying Start)	

Notes:

- ◆ Start from the start-up frequency: Speed up from start-up frequency and accelerate to the setting frequency according to the preset Acc time.
- ◆ First brake (excitation) and then start at the start-up frequency: Inverter adds some DC braking power to load first, and then startup. As shown in Fig. 5-1-1. Starting mode 1 is suitable for small inertia load which is running forward or reverse while the inverter is in stop state, such as fan load. DC braking parameters refer to P1.03 and P1.04.

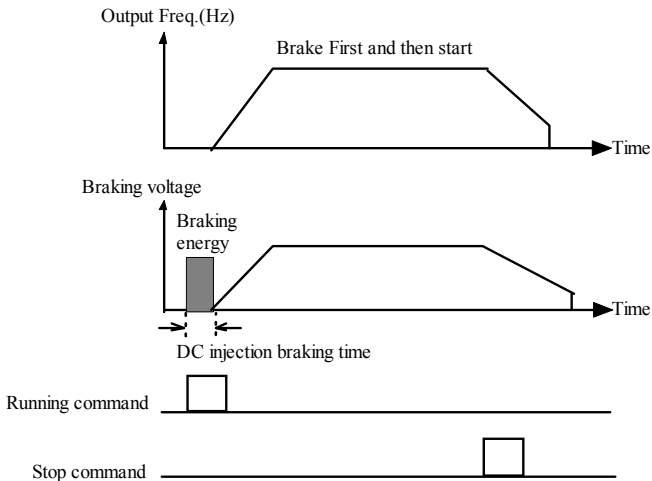

Fig. 5-1-1 Brake first and then start

- ◆ Rotating speed tracking: Detect the motor's running speed, and then start at the detected speed, running to the setting frequency according to the Acc/Dec time, realize smooth start of motor, as shown in Fig. 5-1-2. This mode is suitable for the motor with big inertial load.

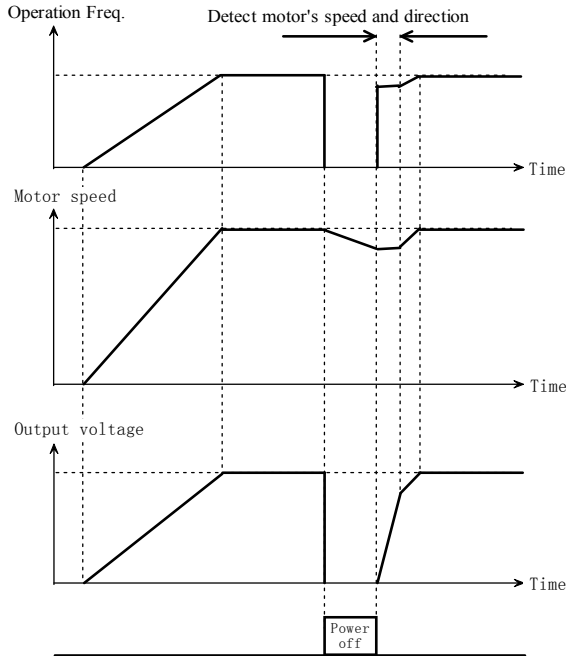

Fig. 5-1-2 Rotating speed tracking restart

- ◆ Starting process includes the first time power up, power recovery, external fault reset, and restart after coast-to-stop.

Tips:

The rotating speed tracking function will be enabled while the inverter takes with encoder (PG) or speed tracking card. There is no speed tracking card in 3004GB and below models, speed tracking card is optional in 35R5GB and above models.

P1.01 Start-up frequency	Setting range: 0.10~60.00Hz [0.50Hz]
P1.02 Start-up frequency hold time	Setting range: 0.0~10.0s [0.0s]

Notes:

Start-up frequency is the initial frequency at which the inverter starts; see "Start Freq." as shown in Fig. 5-1-3; holding time of start-up frequency is the time during which the inverter operates at the start-up frequency, see t_1 as shown in Fig. 5-1-3:

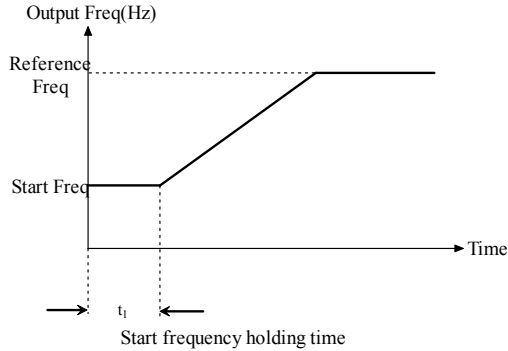

Fig. 5-1-3 Starting frequency and starting time

Tips:

1. Start-up frequency is not restricted by the lower limit frequency.
2. If setting frequency is lower than start-up frequency during acceleration, the inverter will run at zero-speed

P1.03 DC braking current at start-up	Setting range: Depend on model [0.0%]
P1.04 Start-up DC braking hold time	Setting range: 0.0~30.0s [0.1s]

Notes:

- ◆ P1.03 and P1.04 are only active when P1.00 is set to 1 (start mode 1 is selected), as shown in Fig. 5-1-1.
- ◆ In V/F mode, 100.0% corresponds to the rated current of the motor; in vector mode, the start-up DC braking current is determined by P8.00 pre-excitation current compensation coefficient (100.0% corresponds to no-load current of the motor).
- ◆ The set upper limit of the start-up DC braking current is the lower one between 80% of the rated current of the inverter and the full rated current of the motor.
- ◆ When the start-up DC braking time is 0.0s, there is no DC braking process.

table 5-1-1 DC Injection braking function

model	The range of current	The range of time
G type	0.0~100.0%	0.0~30.0s
P type	0.0~80.0%	0.0~30.0s

Tips:

When the rated capacity of the motor is small than that of the inverter, it is suggested to set this parameter(P1.03) according to formula: Motor rated current(A)/inverter rated current(A)*100%.

P1.05 Starting preset frequency	Setting range: 0.00 ~ maximum frequency [0.00Hz]
P1.06 Starting preset frequency hold time	Setting range: 0.0~3600s [0.0s]

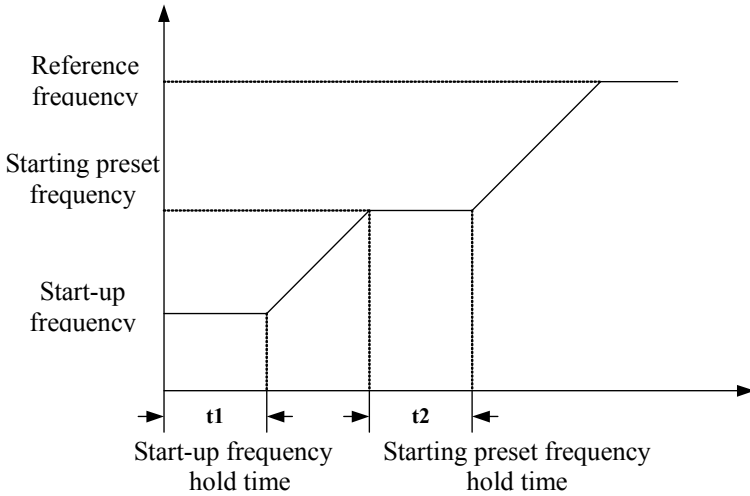

Fig. 5-1-4 Starting preset frequency and hold time

Tips:

When starting preset frequency is less than the start-up frequency or larger than the reference frequency, or starting preset holding frequency time is 0, the starting preset frequency is invalid.

P1.07 Acc/Dec mode	Setting range: 0~3 [0]
0: Linear	1: S-curve
2: Reserved	3: Reserved

Notes:

- ◆ Linear Acc/Dec mode used for ordinary load: The output frequency increases or decreases according to a constant rate. As shown in Fig. 5-1-5.

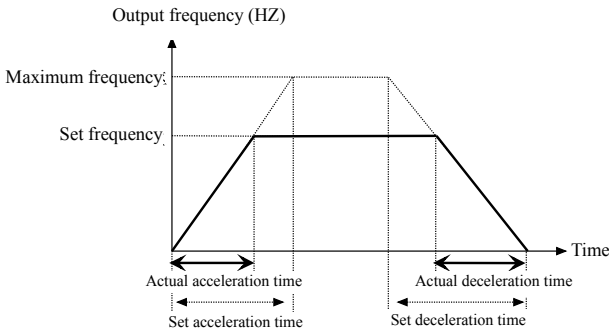

Fig. 5-1-5 Linear acceleration/deceleration

- ◆ S-curve change output frequency slowly at start of acceleration or end of deceleration in order to reduce mechanism noise and shake or current surge at start and stop. It is suitable for the load that needs descending torque at low frequency, and short-time acceleration at high frequency, such as conveying belt.

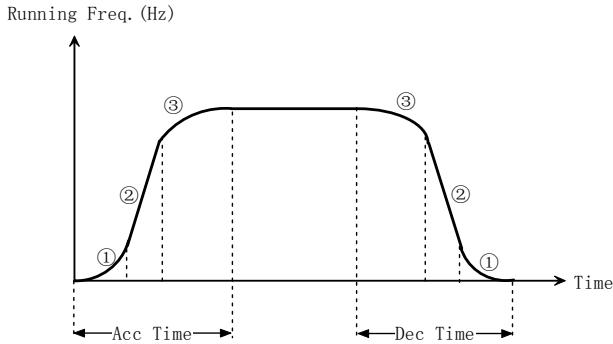

Fig. 5-1-6 S-curve acceleration/deceleration

P1.08 S-curve start time	Setting range: 10.0~50.0% [20.0%]
P1.09 S-curve ascending stage time	Setting range: 10.0~80.0% [60.0%]

Notes:

- ◆ P1.08 and P1.09 are only active when the Acc/Dec mode is S-curve mode (P1.07=1) and $P1.08+P1.09 \leq 90\%$.
- ◆ Starting process of S-curve is shown in Fig. 5-1-6 as “①”, where the changing rate of output frequency increases from 0.
- ◆ Rising process of S-curve is shown in Fig. 5-1-6 as “②”, where the changing rate of output frequency is constant.
- ◆ Ending process of S-curve is shown in Fig. 5-1-6 as “③”, where the changing rate of output frequency decreases to zero.

Tips:

S-curve Acc/Dec mode is suitable for the conveying load such as elevator and conveying belt.

P1.10 Stop mode	Setting range: 0~2 [0]
-----------------	------------------------

0: Deceleration to stop

1: Coast-to-Stop

2: Deceleration + DC braking

Notes:

- ◆ 0: Dec-to-stop
After receiving the stop command, the inverter reduces its output frequency within the Dec time, and stops when the frequency decreases to zero.
- ◆ 1: Coast-to-stop
After receiving the stop command, the inverter stops output immediately and the load stops under the effects of mechanical inertia.

◆ 2: Dec-to-stop +DC braking

After receiving the stop command, the inverter reduces its output frequency according to the Dec time and starts DC braking when its output frequency reaches the preset frequency of braking. Refer to the Notes of P1.11~P1.15 for the functions of DC braking.

P1.11 Stopping DC braking frequency	Setting range: 0.00~MIN (50.00Hz, Frequency upper limit) [1.00Hz]
P1.12 Waiting time before stopping DC braking	Setting range: 0.00~10.00s [0.00s]
P1.13 Setting source of Stopping DC braking current	Setting range: 0~5 [0]
0: Digital setting 2: Terminal AI2 (S2R4GB and S2R75GB have no AI2) 4: Pulse input	1: Terminal AI1 3: Reserve 5: Communication setting
P1.14 Digital setting of stopping DC braking current	Setting range: depend on model [0.0%]
P1.15 stopping DC braking time	Setting range: 0.0~30.0s [0.0s]

Notes:

- ◆ DC braking is injecting DC current to motor to let it stop quickly and keep the spindle of motor in standstill until DC braking finishes.
- ◆ If there is pre-shoot or reversing during Decelerate-to-stop or at FWD/REV dead zone, the value of P1.11 can be decreased or increased accordingly.

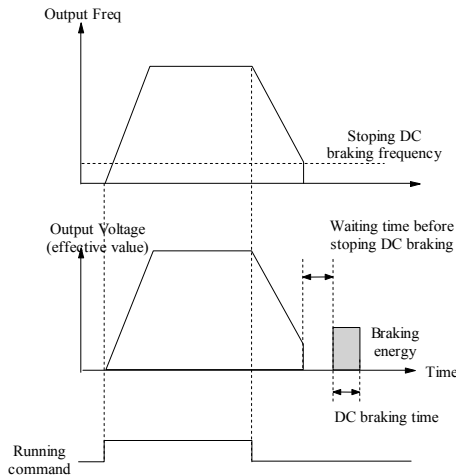

Fig. 5-1-7 DC braking

- ◆ Stopping DC braking frequency is the frequency at which DC braking action begins when the inverter in Dec-to-stop process. In the process of constant rate

deceleration, if the output frequency is at or below the "Stopping DC braking frequency", the DC braking function will startup.

- ◆ The upper limit of the stopping DC braking current is the lower one between 80% of the rated current of the inverter and the full rated current of the motor.
- ◆ When the stopping DC braking time is 0.0s, there is no DC braking process.
- ◆ Stopping DC brake time: It is DC braking current hold time. This time cannot be set too long, as this may cause overheat of the inverter. If the DC braking time is equal to zero, then DC braking does not operate.

Tips:

This function will start up after inverter received stop command. Usually, it is used to improve the stop precision and not for deceleration braking in common running. If faster stop required, braking energy regeneration unit should be fitted, or the inverter that has the function of brake energy regeneration should be selected.

P1.16 Stopping holding frequency	Setting range: 0.00Hz~Maximum frequency [0.00Hz]
P1.17 Stopping holding time	Setting range: 0~3600s [0.0s]

Notes:

- ◆ The stopping holding frequency: under the conditions of press the STOP key or other normal stopping, the operation frequency will drop to stopping holding frequency, then drop to 0.
- ◆ When stopping holding time is 0, or current setting holding frequency is greater than the operation frequency, there is no stopping holding process.

P1.18 Braking selection	Setting range: 0~3 [3]
0: Do not use braking	1: Energy consumption braking is enabled
2: Use magnetic flux braking	3: Use energy consumption and magnetic flux braking

Tips:

On occasions where the load inertia is not great and there is no special requirements on the deceleration time, magnetic flux braking can be used only without connecting braking resistor; while on occasions where the rotary inertia is great, and fast stopping is required, it is suggested to set the parameter to 1 or 3 and select the matching dynamic braking unit and braking resistor. 15kW and below models are designed with built-in braking unit.

P1.19 Energy consumption braking usage	Setting range: 30.0%~100.0% [100.0%]
--	--------------------------------------

Notes:

- ◆ The larger the set value is, the better the braking effect will be got, but the temperature rise of the braking resistor will be greater. Therefore, setting of this parameter should consider the impedance and power of the braking resistor, choose the appropriate usage to achieve a balance between rapid braking and avoiding braking resistor overheat.
- ◆ Energy consumption braking operation voltage point relates to stall overvoltage point (Pd.11). For 380V input models, energy consumption braking operation

voltage point is about 52V lower than stall overvoltage point (namely the default operation point is 700V); for 220V input models, energy consumption braking operation voltage point is about 23V lower than stall overvoltage point (namely the default operation point is 350V). Please see Pd.11 description for more details.

P1.20 Trip-free handling	Setting range: 0~2 [0]
0: Report fault Uu1 once Trip-free	1: Give an alarm Uu within trip-free time, and give fault Uu1 afterwards
2: Give an alarm Uu once Trip-free	
P1.21 Trip-free time	Setting range: 0.5~10.0s [Depend on model]
P1.22 Action selection after trip-free alarm	Setting range: 0~1 [0]
0: No action	1: Slowdown running
P1.23 Rate of deceleration during trip-free slowdown running	Setting range: 0.10Hz/s ~ maximum frequency/s [10.00Hz/s]

Notes:

- ◆ If under-voltage occurs at stopped state, it only give an alarm of Uu, at this time, the motor cannot be started. As shown in Fig. 5-1-8:
- ◆ If under-voltage occurs during running, it will give an alarm of Uu or Uu1 as shown in Fig. 5-1-8; when Uu occurs, the pulse will be locked and the inverter will run at 0Hz frequency. Uu will disappear after the recovery; when Uu1 occurs, the inverter will stop, if the voltage continues to drop to 300V or less, it will not be regarded as a fault record or a fault output; it will record fault Uu1 after the recovery.
- ◆ When P1.22 is selected as 1, the inverter will decelerate according to P1.23 during trip-free alarm. If the mains supply recovers during the deceleration, the frequency should be recovered to the setting frequency according to the set acceleration time.

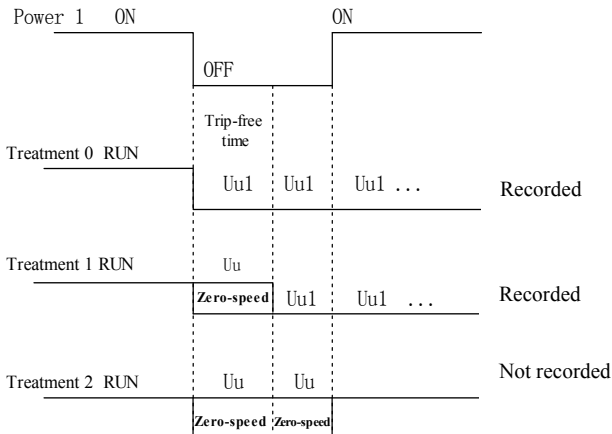

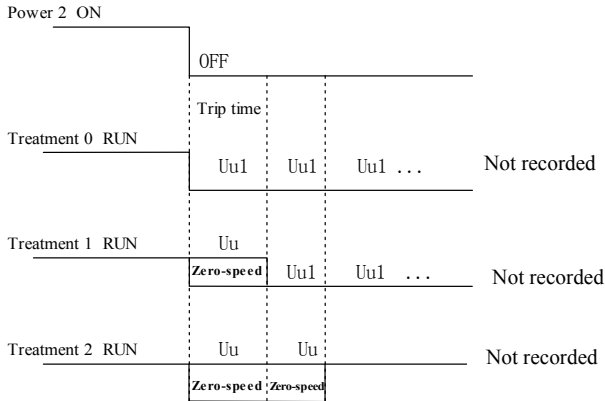

Fig. 5-1-8 Trip-free diagram

5.3 Auxiliary Operation (Group P2)

P2.00 Jog Frequency	Setting range: 0.10~Frequency upper limit [5.00Hz]
P2.01 Jog acceleration time	Setting range: 0.1~3600s [6.0/20.0s]
P2.02 Jog deceleration time	Setting range: 0.0~3600s [6.0/20.0s]

Notes:

- ◆ P2.00~P2.02 define the related parameters of Jog.
- ◆ As shown in Fig. 5-2-1, t₁ is Acc time of Jog and t₃ is Dec time of Jog, t₂ is the Jog time; P2.00 is the Jog frequency.
- ◆ Actual Acc time of JOG (t₁) can be determined by the following formula. So does the actual Dec time of JOG (t₃).
- ◆ JOG stop mode depends the value of P2.02: If P2.02 setting is not 0, the motor will stop as stop mode 0 (Dec-to-stop); if P2.02 setting is 0, the motor will coast to stop

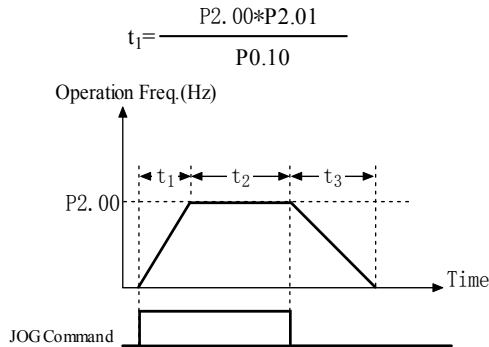

Fig. 5-2-1 Description of Jog parameters

Tips:

1. In Jog operation, the inverter starts according to starting mode 0. The unit of Acc/Dec time is second.
2. If deceleration time of Jog is 0: coast-to-stop, but DC braking terminal takes effect during jog running, the deceleration time will be P2.33 Dec time 4.
3. Jog operation can be controlled by keypad or terminals.

P2.03 Switching time between run forward and reverse
--

Setting range: 0.0~3600s [0.0s]

Notes:

- ◆ The switching time is the transition time at zero frequency when the inverter switching its running direction as shown in Fig. 5-2-2 as t1.

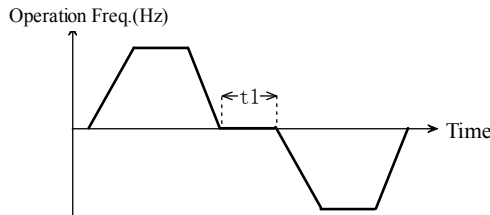

Fig. 5-2-2 FWD/REV switching time

P2.04 Lower limit frequency handling mode

Setting range: 0~3 [0]

- 0: Running at lower limit frequency
- 2: Stopping

- 1: Running at zero-frequency.
- 3: Reserve

Notes:

- ◆ Option 0: when the setting frequency is lower than lower limit frequency, the inverter will run at lower limit frequency instead of setting frequency. As shown in Fig. 5-2-3.

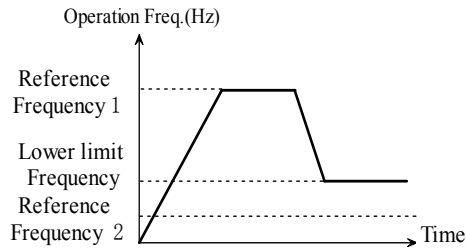

Fig. 5-2-3 Running at lower limit frequency

- ◆ Option 1(Zero frequency running): if the setting frequency is lower than the lower limit frequency, the inverter should run at the lower limit frequency, and run at 0 frequency after the delay time arrives at P3.30, as shown in Fig. 5-2-4.

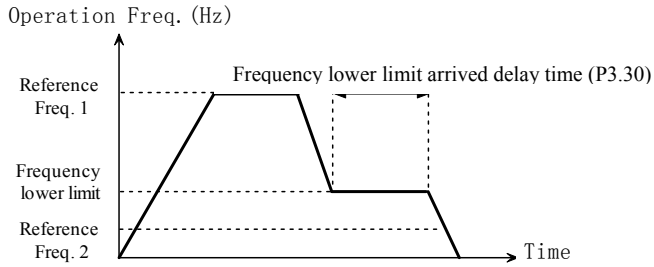

Fig. 5-2-4 Zero-speed running

- ◆ Sleep function is enabled and the inverter is in sleep running, and then no matter P2.04 is 0 or 1, the inverter should be running at zero-frequency.

P2.05 Frequency deviation setting	Setting range: 0.00~2.50Hz [0.10Hz]
-----------------------------------	-------------------------------------

Notes:

- ◆ Prevent analog setting fluctuation leading joggling of output frequency. When the frequency setting source is terminal AI or pulse input, it takes effect only when the setting frequency changes and the variation range exceeds the set range.

P2.06 Carrier frequency adjustment selection	Setting range: 0, 1 [0]
--	-------------------------

0: No automatic adjustment

1: Adjust automatically according to the load and the temperature of the inverter

Notes:

- ◆ The carrier frequency is fixed to P2.07 carrier frequency in vector control mode or when there is no automatic adjustment.
- ◆ Option 1: This function option can adjust the carrier frequency by automatically synthesizing the load and temperature of the inverter so as to regulate the width of the frequency domain of the noise of the motor or reduce the probability of inverter overheat alarm.

P2.07 Carrier frequency	Setting range: Depend on model
P2.08 Lower limit of Carrier frequency	Setting range: 1.0~P2.07 [1.0KHz]

Notes:

- ◆ In order to obtain better control characteristics, it is suggested that the ratio of the carrier frequency and the maximum operating frequency of the inverter is not less than 36.
- ◆ To reduce the noise, higher carrier frequency can be selected; if the inverter is not required to be absolutely quiet during running, lower carrier frequency can be used to reduce loss of the inverter and intensity of radio-frequency radiation.
- ◆ If the used carrier frequency is greater than the factory set value, then the rated continuous-service current of the inverter will be reduced.

P2.09 Jump frequency 1	Setting range: 0.00~Max frequency [0.00Hz]
------------------------	--

P2.10 Jump frequency 2	Setting range: 0.00~Max frequency [0.00Hz]
P2.11 Jump frequency 3	Setting range: 0.00~Max frequency [0.00Hz]
P2.12 Jump frequency bandwidth	Setting range: 0~15.00Hz [0.00Hz]

Notes:

- ◆ In order to make the setting frequency of the inverter avoid the resonance frequency point of the mechanical load, the setting frequency of the inverter can hop near some frequency point. The operating frequency corresponding to the resonance frequency is jump frequency as shown in Fig. 5-2-5.

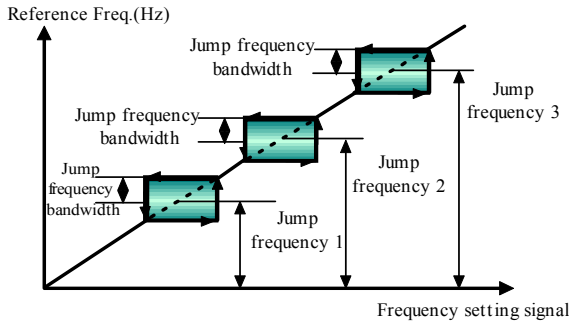

Fig. 5-2-5 Jump Frequency

- ◆ The inverter can set three jump frequency points, and the jump frequency bandwidth can overlap or nesting. If overlapped, the range broadens. When all three jump frequency set to 0.00 Hz, the jump function will be disabled.

P2.13 Multi-step frequency 1	Setting range: 0.00~Max frequency [5.00Hz]
P2.14 Multi-step frequency 2	Setting range: 0.00~Max frequency [8.00Hz]
P2.15 Multi-step frequency 3	Setting range: 0.00~Max frequency [10.00Hz]
P2.16 Multi-step frequency 4	Setting range: 0.00~Max frequency [15.00Hz]
P2.17 Multi-step frequency 5	Setting range: 0.00~Max frequency [18.00Hz]
P2.18 Multi-step frequency 6	Setting range: 0.00~Max frequency [20.00Hz]
P2.19 Multi-step frequency 7	Setting range: 0.00~Max frequency [25.00Hz]
P2.20 Multi-step frequency 8	Setting range: 0.00~Max frequency [28.00Hz]
P2. 21 Multi-step frequency 9	Setting range: 0.00~Max frequency [30.00Hz]
P2.22 Multi-step frequency 10	Setting range: 0.00~Max frequency [35.00Hz]
P2.23 Multi-step frequency 11	Setting range: 0.00~Max frequency [38.00Hz]
P2.24 Multi-step frequency 12	Setting range: 0.00~Max frequency [40.00Hz]
P2.25 Multi-step frequency 13	Setting range: 0.00~Max frequency [45.00Hz]
P2.26 Multi-step frequency 14	Setting range: 0.00~Max frequency [48.00Hz]
P2.27 Multi-step frequency 15	Setting range: 0.00~Max frequency [50.00Hz]

Notes:

- ◆ Define Multi-step frequency respectively, which can be used in Multi-step speed running and simple PLC running.

P2.28 Acceleration time 2	Setting range : 0.1~3600s [6.0/20.0s]
P2.29 Deceleration time 2	Setting range : 0.1~3600s [6.0/20.0s]
P2.30 Acceleration time 3	Setting range : 0.1~3600s [6.0/20.0s]
P2.31 Deceleration time 3	Setting range : 0.1~3600s [6.0/20.0s]
P2.32 Acceleration time 4	Setting range : 0.1~3600s [6.0/20.0s]
P2.33 Deceleration time 4	Setting range : 0.1~3600s [6.0/20.0s]
P2.34 Deceleration time during abnormal stopping	Setting range : 0.1~3600s [3.0/10.0s]

Notes:

- ◆ Define acceleration and deceleration time 2, 3, 4 respectively (acceleration and deceleration time 1 is defined by P0.18 and P0.19). Acceleration time and deceleration time during inverter operation are determined by external terminal via parameters P3.01 ~ P3.05; if they are all disabled, then acceleration and deceleration time 1 is adopted. When the terminal option is forced stopping or in cases of abnormal stopping, deceleration performs according to deceleration time during abnormal stopping (P2.34). Acceleration and deceleration time of PLC run and jog run is out of control of external terminals, but is selected by the set parameters.
- ◆ When the inverter is in unusual stopping or terminal forced stopping, it should be stopped according to P2.34 abnormal deceleration stopping time, is subject to the limit of stop mode (P1.10).
- ◆ The default units of acceleration and deceleration time is s, the acceleration and deceleration time can be reduced or enlarged to 10 times by modifying P2.35.

P2.35 Multiplying factor of acceleration and deceleration time	Setting range: 0~2 [0]
--	------------------------

0: 1 times

1: 10 times

2: 0.1 times

Notes:

- ◆ Actual acceleration and deceleration time = acceleration and deceleration time × Multiplying factor of acceleration and deceleration time

P2.36 Fan control mode	Setting range: 0, 1 [0]
------------------------	-------------------------

0: Auto stop mode

1: The fan keeps running after power on

Notes:

- ◆ Auto stop mode
The fan keeps running during inverter operation, internal temperature detection program starts automatically 3 minutes after the inverter stops. Running and stopping of the fan is dependent on the module temperature conditions. When the module temperature is lower than 50°C, the fan will stop. Otherwise the fan will automatically shut down after 30 minutes.
- ◆ The fan runs after power on
The fan keeps running after power on the inverter

P2.37 Wiring direction of motor	Setting range: 0, 1 [0]
---------------------------------	-------------------------

0: Positive sequence 1: Inverted sequence

Notes:

- ◆ The inverter output positive rotation direction may be inconsistent with the actual positive rotation direction of the motor. Users can change phase sequence of incoming line of the motor or change this function code to adjust the rotation direction of the motor.

P2.38 Anti-reverse selection	Setting range: 0, 1 [0]
------------------------------	-------------------------

0: Reverse rotation is enabled 1: Reverse rotation is disabled

Notes:

When it is set to 1: Reverse rotation is disabled,

- ◆ When the keypad is set to reverse running, the inverter will run at zero-frequency
- ◆ When terminal RJOG reverse jog is enabled, the inverter shall not run.
- ◆ When the Run command is controlled by terminal and when REV reverse rotation terminal is enabled, the inverter shall not run.

P2.44 Built-in PG pulse number per revolution	Setting range: 1~9999 [1000]
---	------------------------------

Notes:

- ◆ P2.44: Set according to pulse number per revolution of the actually used pulse encoder.

P2.47 PG disconnection detection time (reserve)	Setting range: 0.0~10.0 [2.0s]
P2.48 PG disconnection operation selection (reserve)	Setting range: 0~3 [1]

0: Deceleration stopping 1: Coast-to-stop
 2: Abnormal stopping 3: Continue to run

Notes:

- ◆ When the inverter is controlled with an encoder, P2.47 is used to define encoder signal disconnection detection time. If the encoder is disconnected for longer than the time set by P2.47, then the inverter will operate according to the operation defined by P2.48.

P2.49 PG reduction teeth number 1	Setting range: 1~1000 [1]
P2.50 PG reduction teeth number 2	Setting range: 1~1000 [1]

Notes:

- ◆ When the encoder (PG) is not mounted directly on the motor shaft, the parameters is required to be set, number of PG reduction teeth 1 is the same with the number of teeth of the driving gear on the motor shaft or the diameter; number of PG reduction teeth 2 is the same with the number of teeth of the driving gear on PG mounting shaft or the diameter.

P2.51 JOG key's function selection	Setting range: 0, 1[0]
------------------------------------	------------------------

0: JOG key 1: FWD/REV key

- ◆ Notes: Used for setting the inching function in the keypad;

- ◆ When set to 0, it acts as an inching key: in state of the keypad monitoring, the inverter will inching when press this key; when set to 1, it acts as an direction switch key: in state of the keypad monitoring, the inverter's moving direction will change when press this key.

P2.52 Enabling keypad keys UP/DN	Setting range: 0, 1 [0]
0: Invalid	1: Enabled

Notes:

- ◆ In the case the digital encoder is damaged, the function can be set as 1 to enable the keypad key UP/DN manner. The keypad key JOG acts as the UP key and the RUN key acts as the DN key
- ◆ This function can be also activated by the combination keys: Pressing Shift +JOG for 5s to enable UP/DN keys. (this manner can only be set and effective when the function group is displayed, and will not be saved after power off)

P2.53 Select high / low frequency ode(reserve)	Setting range: 0, 1[0]
0: low frequency mode(0.00~400.0Hz)	1: high frequency mode(0.0Hz~1000Hz)

Notes:

- ◆ This parameter is used to switching the mode of high-low frequency, namely setting the resolution rate and the range of frequency including communication setting frequency and so on;
- ◆ When set to 0, the resolution rate of the setting frequency is 0.01Hz and its range is 0.00~400.00Hz; when set to 1, the resolution rate is 0. 1Hz and its range is 0.0~1000.0Hz.

P2.54 Reversed rotation upper limit frequency	Setting range: 0.00Hz~maximum frequency [0.00Hz]
---	--

Notes:

- ◆ This parameter is used for setting the maximum operating frequency of the direction opposite to the command.

P2.55JOG priority enable	Setting range: 0, 1[0]
--------------------------	------------------------

Notes:

- ◆ P2.55 is used for enabling JOG priority.

JOG is active during STOP or RUN mode when P2.55 is set to 1; JOG is only active during STOP mode when P2.55 is set to 0.

5.4 I/O Terminal Ctrl (Group P3)

P3.00 Terminal function mode	Setting range: 0, 1 [0]
0: Close is active	1: Open is active

Notes:

- ◆ Close valid: Signal is enabled if the control terminal and COM terminal are short-circuited;
- ◆ Open valid: Signal is disabled if the control terminal and COM terminal are short-circuited.

- ◆ Normally open and normally closed is not subject to the limit of this function.

S2R4GB, S2R75GB:

P3.01 X1 terminal function	Setting range: 0~79 [1]
P3.02 X2 terminal function	Setting range: 0~79 [2]
P3.03 X3 terminal function	Setting range: 0~79 [37]
P3.04 X4 terminal function	Setting range: 0~79 [0]
P3.05 X5 terminal function	Setting range: 0~81[0]

S21R5GB, S22R2GB, 3R75GB/31R5PB and above:

P3.01 X1 terminal function	Setting range: 0~79[1]
P3.02 X2 terminal function	Setting range: 0~79[2]
P3.03 X3 terminal function	Setting range: 0~79[37]
P3.04 X4 terminal function	Setting range: 0~79, 82[0]
P3.05 X5 terminal function	Setting range: 0~81[0]
P3.06 X6 terminal function	Setting range: 0~80[0]

Notes:

- ◆ Control terminals X1 ~ X6 are multi-function terminals, their specific functions can be defined by setting the value of P3.01 ~ P3.06. Redefinition is allowed. Among repeatedly defined terminals, when one terminal is active, this function is enabled. Setting and functions are as shown in Table 5-3-1.

Table 5-3-1 Multi-function Input Menu

Setting	Function	Setting	Function
0	NULL: Not defined	1	FWD: Forward Running
2	REV: Reverse Running	3	RUN Running
4	F/R: Rotation direction	5	HLD: Self-holding
6	RST: Reset	7	FC: Frequency setting combination selection
8	FJOG: JOG FWD	9	RJOG: JOG REV
10	UP	11	DOWN
12	UP/DOWN Reset	13	FRE: Coast to stop
14	Forced stopping (According to deceleration time during abnormal stopping)	15	Stopping process DC braking
16	Acc/Dec prohibit	17	Inverter running prohibit
18	S1 Multi-step Speed 1	19	S2 Multi-step Speed 2
20	S3 Multi-step Speed 3	21	S4 Multi-step Speed 4
22	S5 Multi-step Speed 5	23	S6 Multi-step Speed 6
24	S7 Multi-step Speed 7	25	Command channel switch to Terminal control 2
26	SS1 Multi-step Speed	27	SS2 Multi-step Speed
28	SS3 Multi-step Speed	29	SS4 Multi-step Speed

Setting	Function	Setting	Function
30	T1 Acc/Dec time 1	31	T2 Acc/Dec time 2
32	T3 Acc/Dec time 3	33	T4 Acc/Dec time 4
34	TT1 Acc/Dec time	35	TT2 Acc/Dec time
36	Forced stopping normally closed	37	EH0: External fault normally open
38	EH1: External fault normally closed	39	EI0: External interrupt normally open
40	EI1: External interrupt normally close	41	Stop state DC brake
42	Start PLC operation	43	Pause the PLC operating
44	Reset PLC stop status	45	Reserve
46	Reserve	47	Start PID operation
48	Speed/torque mode switching	49	Timing drive input
50	Counter trigger signal input	51	Counter reset
52	Reserve	53	Timing unit selection
54~73	Reserve	74	output terminal control
75~76	Reserve	77	PID output is forced to 0
78	PID integral time reset	79	Command channel switch to Keypad control
80	PUL: Pulse input	81	Single phase speed measurement pulse or double phase speed measurement A phase pulse input
82	Double phase speed measurement B phase pulse input		

Notes to functions listed in Table 5-3-1:

0: NULL: Not defined

- ◆ The defined terminal is invalid. The inverter does not detect the status of the terminal nor response to the terminal. In other words, the function of terminal is forbidden. To avoid disturbance or mistake action effectively, define the terminals that are not in use as this function

1~ 5: Operation mode

- ◆ See P3.15 operation mode setting

6: RST: Reset

- ◆ In fault state, the inverter can be reset by pressing “STOP/RESET” on keypad or by terminal which is defined as RST function. In running state, enabling this terminal function can stop the inverter according to selected stop mode. RST function is rising-edge-triggered, so it must be operated as “disabled-enabled-disabled”, shown in Fig. 5-3-1.

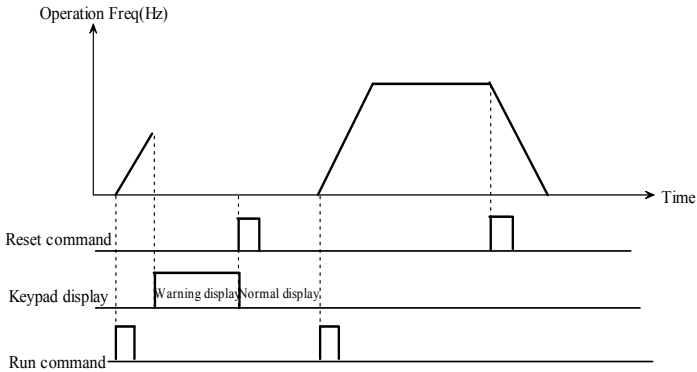

Fig. 5-3-1 Terminal reset

7: Frequency setting combination selection

◆ FC frequency setting options: If the "FC frequency setting option" is enabled and valid, the frequency reference is determined by P0.06 frequency setting combination 2; if this function terminal is inactive, the frequency reference is determined by P0.05 frequency setting combination 1. During inverter operation, frequency setting mode can be switched through FC terminal to control the inverter output frequency flexibly.

8~9: Jog operation signal (FJOG/RJOG)

◆ If setting is 8 or 9, this terminal is defined as FJOG or RJOG. When the inverter is not running to RUN command (No frequency output), this terminal can do forward jogging or reversed jogging actions accordingly as shown in Fig.5-3-2. The defined Jog function of terminal isn't limited by *Control Command Set Channel* (P0.07). Jog frequency and jog Acc/Dec time can be defined in P2.00~P2.02.

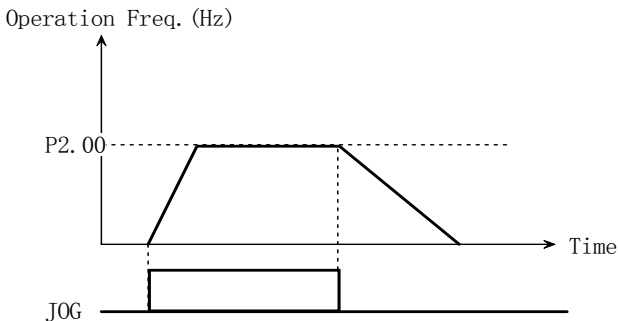

Fig. 5-3-2 JOG operation

10~12: UP/DOWN

◆ When P0.05 setting is 4, the frequency is set to frequency source1+frequency source2:

At the beginning of the running, whether the UP/DOWN terminals are both effective or neither of them are effective, the reference frequency will be the sum of initial value of UP/DOWN and frequency setting 2. If either UP/DOWN terminal is effective, the frequency will increase or decrease at the rate of UP/DN rate (P3.16). And the UP/DOWN frequency range will be (frequency source 2—P3.17) ~ (Frequency Source 2+P3.17). If UP/DOWN function terminal is not effective, the frequency reference of UP/DOWN will keep constant. When UP/DN is invalid, pressing STOP key will save/not save the UP/DN value according to P3.18 UP/DN storage selection. But if UP/DOWN function is effective, pressing STOP will keep UP/DOWN to be initial value. As shown in Fig.5-3-3.

- ◆ When P0.05 is not 4, the frequency is set to frequency source 1 and its setup is terminal UP/DN:

At the beginning of the running, if UP/DOWN terminals are all inactive or both active, then the inverter runs at the initial set point of UP/DOWN (if the value is negative, the inverter runs at 0 frequency); if either terminal of UP/DOWN is active, then the set frequency is controlled by UP/DOWN terminal, increase or decrease on the basis of the current speed at the speed of terminal UP/DOWN (P3.16). At this point, if the UP/DOWN terminal is inactive, the running frequency at this time is the set frequency. When the UP/DOWN terminal is inactive, press STOP key, save the current set frequency to the given value of UP/DOWN in the method determined by the function code P3.18 with the sign as positive. When the UP/DOWN terminal is active, pressing STOP key will keep UP/DN value to be initial value as shown in Fig. 5-3-3.

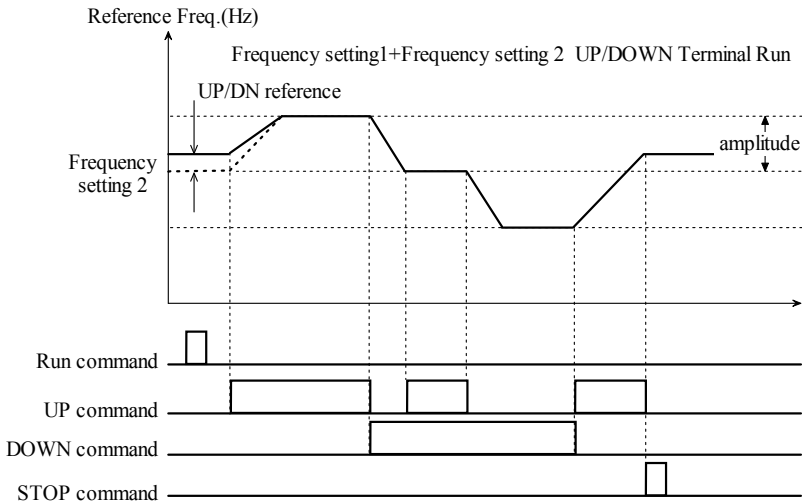

Fig. 5-3-3 UP/DOWN combination operation

NOTES: The terminal UP/DOWN is active only when P0.03 = 9 and when the inverter is in running state.

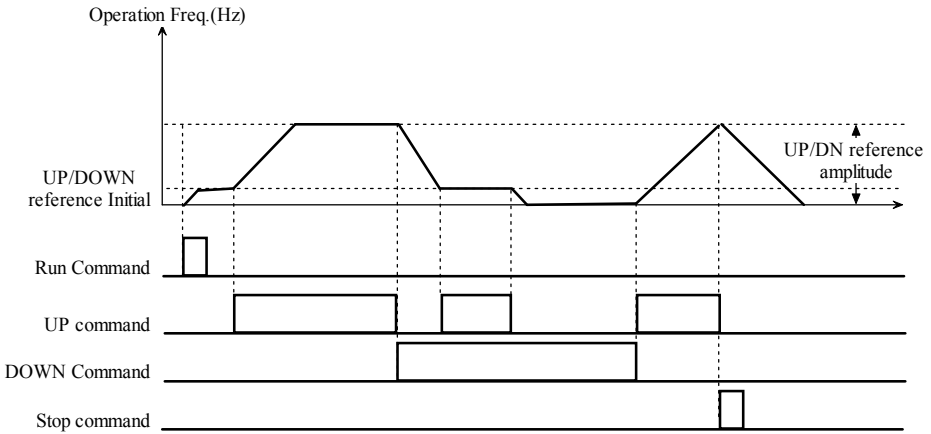

Fig. 5-3-4 UP/DOWN non-combination operation

13: FRE Coast to stop

- ◆ When defining terminal of this function is active, the inverter immediately locks PWM output, and exits running state. Only when FRE is removed, the run command takes effect. Once the function is defined, no matter the control mode (P0.07) is what value, the function is active and is not subject to the limit of stop mode (P1.10).

14: Forced stopping; 36: Forced stopping normally closed
(According to deceleration time during abnormal stopping)

- ◆ Dec-to-stop according to deceleration time of abnormal stopping (P2.34). It is subject to the limit of stop mode (P1.10).

15: Stopping process do DC braking

- ◆ Use the terminal to perform DC braking to the system during the stopping process for accurate positioning of the motor. Braking starting frequency, braking waiting time, brake current are defined in P1.11 ~ P1.14; the braking time is bigger one between the time defined by P1.15 and the effective duration of the control terminal, which is as shown in Fig. 5-3-5.

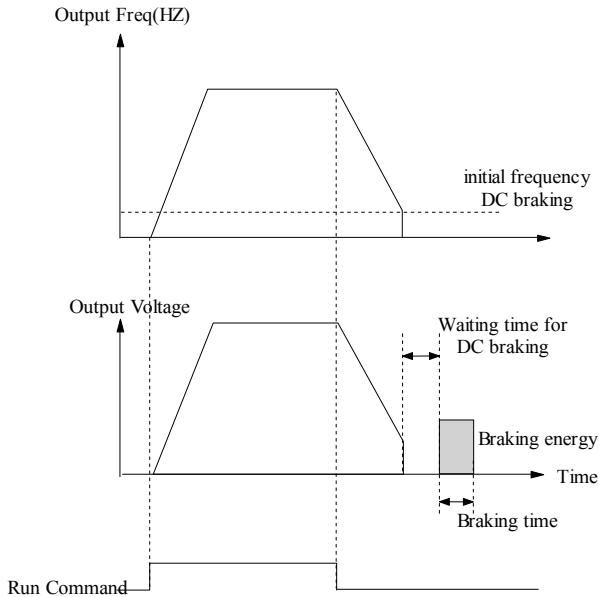

Fig. 5-3-5 DC braking

16: Acc/Dec prohibit

- ◆ The motor operate at present speed without being influenced by external signal (except STOP command).

17: Inverter running prohibits

- ◆ When the terminal is active, the inverter during running will coast to stop, and in the standby state inverter is prohibited to start. It is mainly used in occasions where safety interlock is needed.

18 ~ 24, 26 ~ 29: Multi-step speed

- ◆ Start/stop control of Multi-step speed operation can choose keypad, terminal command or serial communication. S1 ~ S7: Multi-step speed command, it is used to specify that the setting frequency of the inverter is one specific step from Multi-step speed frequency S1 to S7 (P3.01 ~ P3.11). If two or more Multi-step speeds are active, the terminal of smaller number takes precedence. SS1 ~ SS4 Multi-step speed command, defined through combination, is used to specify the Multi-step speed, and it has up to 15 steps of speed. As shown in Table 5-3-2:

Table 5-3-2 Multi-step frequency

Selected frequency					Legend
SS4	SS3	SS2	SS1	Frequency setting	
OFF	OFF	OFF	ON	Multi-step 1	
OFF	OFF	ON	OFF	Multi-step 2	
OFF	OFF	ON	ON	Multi-step 3	
OFF	ON	OFF	OFF	Multi-step 4	
OFF	ON	OFF	ON	Multi-step 5	
OFF	ON	ON	OFF	Multi-step 6	
OFF	ON	ON	ON	Multi-step 7	
ON	OFF	OFF	OFF	Multi-step 8	
ON	OFF	OFF	ON	Multi-step 9	
ON	OFF	ON	OFF	Multi-step 10	
ON	OFF	ON	ON	Multi-step 11	
ON	ON	OFF	OFF	Multi-step 12	
ON	ON	OFF	ON	Multi-step 13	
ON	ON	ON	OFF	Multi-step 14	
ON	ON	ON	ON	Multi-step 15	
OFF	OFF	OFF	OFF	General operation	

- ◆ If one or more terminal(s) among the 4 terminals is (are) not set, the terminal(s) not set is (are) default as OFF. Duplicate definition is allowed. Among repeatedly defined terminals, when one terminal is active, this function is enabled.
- ◆ If you define both S1 ~ S7 and SS1 ~ SS4 at the same time, then terminals S1 ~ S7 take precedence.

25: Command channel switch to the terminal control 2

- ◆ When this function is enabled, the command channel is switched to terminal control 2.

30~35: Default acceleration and deceleration

- ◆ T1 ~ T4: Individually specify the acceleration and deceleration time during running. If two or more acceleration and deceleration times are active, the terminal of smaller number takes precedence.
- ◆ TT1 ~ TT2: Combination specifying the acceleration and deceleration time of the running time. As shown in Table 5-3-3.

Table 5- 3- 3

T2	TT1	The selected acceleration and deceleration time
OFF	OFF	Acceleration and deceleration time 1
OFF	ON	Acceleration and deceleration time 2
ON	OFF	Acceleration and deceleration time 3
ON	ON	Acceleration and deceleration time 4

- ◆ If simultaneously defined T1~T4 and TT1~TT2, T1~T4 is prior.
- 37~40: External fault signal / External interrupt signal normally open / normally closed
- ◆ EH0 - External fault signal normally open / EH1 - External fault signal normally close: This is to define external fault command. If the setting is 37~38, the fault signal of external equipment can be input by the terminal. Once the inverter receives the fault signal, it stops output immediately, and displays last fault code. After the external fault signal is removed, the inverter needs to be reset before restarting. Tips: Inverter can't reset if external fault signal isn't released. EH0 and EH1 are not influenced by P3.00, Shown in Fig. 5-3-6.
 - ◆ EI0 - External interrupt signal normally open / EI1 - External interrupt signal normally closed: During operating, the inverter stops its output and runs at zero-speed when it receives external interrupt signal. Once the signal is removed, the inverter will start and resume normal operation. Please refer to note of EH0 and EH1 above. As shown in Fig. 5-3-6.

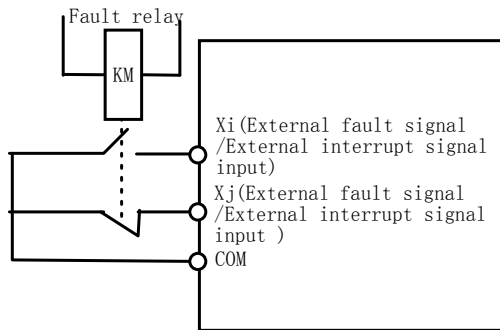

Fig. 5-3-6 Normally open / normally closed

41: Stop State DC brake

- ◆ Use the terminal to inject DC brake on the system in the stopping state to prevent motor malfunction.

42~44: Terminal PLC Control

- ◆ Start PLC operation: Simple PLC running. Replace the frequency setting 1 with PLC; Start PID operation input is the same. When using frequency setting source 2, start PLC operation is inactive.
- ◆ Pause the PLC operation: When the terminal is active, pause the PLC running, and the inverter runs at zero-frequency; it will resume running from the breakpoint after canceling the pause command. When pressing "STOP" key during effective period of the terminal, the program running counter is cleared, it needs to start in the start-up mode when starting up next time. If the inverter does not work under PLC run mode, then the function is meaningless.
- ◆ Reset PLC stop status: stopping state under the PLC operating mode, when the function terminal is active, the running step, running time and other information

recorded at the time of stopping of PLC will be cleared.

47: Start PID operation

- ◆ PID running, replacing the frequency setting 1 with PID closed loop. When using frequency setting source 2, this function is inactive

48: Speed/torque mode switching

- ◆ Under vector control mode, the running speed mode/torque mode is decided by the co-effect of P8.10 setting and this terminal definition. For example: when P8.10=0 (speed mode), at the same time when the terminal is set to 48 and valid, the operation mode is automatically switched to the torque mode.

49, 53: Timing drive input

- ◆ If the terminal is defined to No.49 and valid, inverter starts the timing, or else zero-clear.
- ◆ If the timing arrives at preset setting of P3.33, inverter stops timing. As shown in Fig.5-3-7:
- ◆ When the terminal is defined to No.53 and valid, the unit of P3.33 will be minutes, otherwise it will be second.

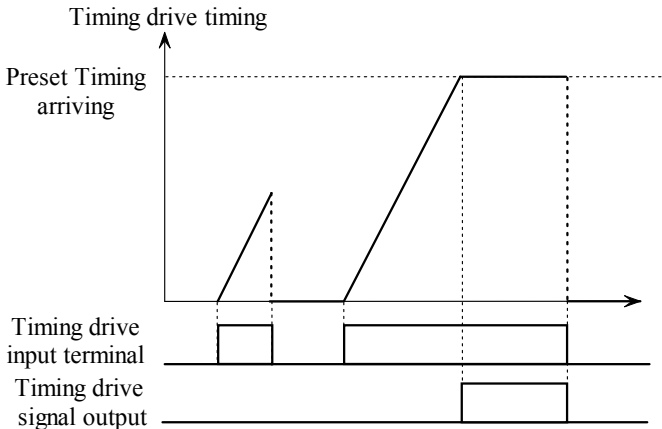

Fig. 5-3-7 Timing driving input

50: Counter trigger signal input

- ◆ This terminal is used for pulse input to the internal counter of the inverter. The highest pulse frequency is 200Hz. The current counting value can be saved when power off.

51: Counter reset

- ◆ This terminal is used to clear the counter to zero. The terminal function is used in conjunction with Counter's trig signal input.

74: Output terminal control

- ◆ When the input signal of this terminal is active, the No.36 terminal output is active.

77: PID output is forced to 0

- ◆ During speed PID run time, when the terminal is active, the output is forced to the set speed; during analog PID run time, when the terminal is active, the output is forced to zero frequency;

78: PID integral time reset

- ◆ In the PID operation mode, it is PI control generally. When the terminal is set and valid, there will be only proportional regulation and the integral regulation is 0.

79: Command channel switch to the keypad control

- ◆ When this function is enabled, the command channel is switched to keypad control.

80: PUL: Pulse input

- ◆ The input pulse frequency can be used as frequency reference. See Parameter Group P4 for the relationship between input pulse frequency and the setting frequency.

81: Single phase speed measurement pulse input

- ◆ Built-in PG card single-phase tachometer pulse input terminal function. Terminals specified by this function are connected to Phase-A pulse of pulse generator or encoder (PG) to achieve single-phase pulse speed feedback.

82: Double phase measure speed B phase pulse input Dual-phase speed feedback control can be realized by using this terminal and the number 81 function by internal PG.

Tips:

Built-in PG card only supports incremental collector output type photoelectric encoder with the voltage range of 12 ~ 30 VDC, and the connection mode is shown in section 2.4.2.

P3.13 X terminal filter time	Setting range: 0.002s~1.000s [0.010s]
------------------------------	---------------------------------------

Explanation:

- ◆ The filter time constant will do digital filtering on the input signal to prevent the interference signal influencing the system stability.
- ◆ If the filter time constant is too large, the control is stable, but control response is bad; if the filter time constant is too small, the response is fast, but the control may not be stable. If the best setting value is unknown, you can appropriately adjust the setting value according to the instability or response delay.

P3.15 Operation mode setting	Setting range: 0~3 [0]
------------------------------	------------------------

- 0: Two-wire operation mode 1 1: Two-wire operation mode 2
 2: Three-wire operation mode 1 - self hold function (add any one of X1 ~ X6 terminals)
 3: Three-wire operation mode 2 - self hold function (add any one of X1 ~ X6 terminals)

Notes:

- ◆ Only when the inverter operation command control mode (P0.07) is terminal control mode, two-wire 1 and 2, three-wire 1 and 2 are meaningful.
- ◆ 2-wire control mode 1

FWD, REV: Running at preset direction. FWD means running forward, and REV means running reverse. You can control the motor's running direction by switch terminal FWD and REV. If FWD is valid, run forward; if REV is valid and P2.38 is set to 1 (Prohibit reverse operation enabled), the inverter will stop. If P2.38 is 0 (Prohibit reverse operation disabled), the inverter will run reverse. If FWD and REV are valid or invalid at the same time, the inverter will stop. Terminals wiring is shown in Fig.1

◆ 2-wire control mode 2

In this mode, both terminals RUN (Run command) and F/R (Running direction) are used together: If RUN is enabled, the inverter will startup. If F/R is selected but disabled, the inverter will run forward. If F/R is selected and enabled, the inverter will run reverse. When F/R is not selected, the running direction is defined by function code. If RUN is disabled, the inverter will stop. Terminals wiring is show in Fig.2

◆ 3-wire control mode 1

FWD, REV: Run at preset direction. FWD means running forward, and Rev means running reverse. You can control the motor's running direction by switch terminal FWD and REV. If FWD is enabled, the inverter will run forward; If REV is enabled, the inverter will run reverse. If both FWD and REV are enabled or disabled, the inverter will stop.

If HLD is ON, FWD and REV signal will self-hold. If HLD is OFF, the inverter will release self-holding and stop. Terminals wiring is show in Fig.3

◆ 3-wire control mode 2

In this mode, both terminals RUN (Run command) and F/R (Running direction) are used: If RUN is enabled, the inverter will startup. If F/R is selected but disabled, the inverter will run forward. If F/R is selected and enabled, the inverter will run reverse. When F/R is not selected, the running direction is defined by function code. If RUN is disabled, the inverter will stop. If HLD is ON, RUN signal will self-hold. If HLD is OFF, the self-holding will be released and inverter stops. Terminals wiring is show in Fig.4.

◆ In Fig. 3, SB1 is Stop button, SB2 is running forward button. Press SB2 or SB3 to startup the inverter, and switch SB2, SB3 to change the running direction. Press SB1 to stop the inverter output.

◆ In Fig.4, SB1 is Stop button, SB2 is running button, and K is running direction button. Press SB2 to startup the inverter. Press the switch K to change the running direction. Press SB1 to stop the inverter output.

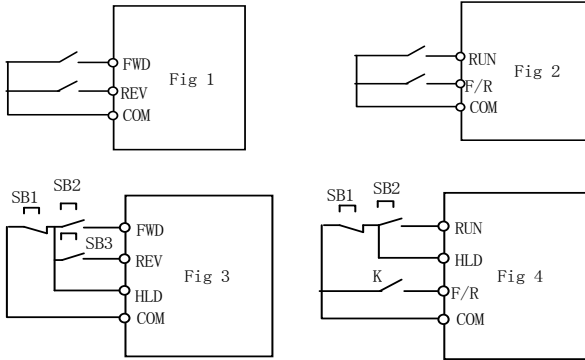

P3.16 Terminal UP/DN speed	Setting range: 0.01~99.99Hz/s [1.00Hz/s]
P3.17 UP/DN setting amplitude	Setting range: 0.00~Frequency upper limit [10.00Hz]

Notes:

- ◆ Terminal UP/DN speed is used to define the change rate of setting frequency that is changed by terminal UP/DN. UP/DN setting amplitude used to define that the span of setting frequency is changed by terminal UP/DN.

P3.18 Digital frequency UP/DOWN save selection	Setting range: 0~2 [2]
--	------------------------

- 0: UP/DN set point is reset to 0 after receiving STOP;
- 1: UP/DN set point is not reset to 0 after receiving STOP, which will not save after power off
- 2: UP/DN set point is not reset to 0 after receiving STOP, which will save after power off; when P0.03 is set to 1, P0.02 will save while power off.

Notes:

- ◆ UP/DOWN operation's shown in Fig. 5-3-3 and 5-3-4.
- ◆ When P0.03 is set to 1 during the keypad setting frequency: When P3.18 is set to 2, the digital set frequency (P0.02) adjusts online saving; when P3.18 is not set to 2, it will not be saved after power failure, please see P0.02 description for details.

P3.19 DO terminal function definitions	Setting range: 0~37 [0]
P3.24 relay 1 (TA/TB/TC) output function selection	Setting range: 0~37 [19]

Table 5-3-4 Multi-function Terminal Output Value

	Function setting	Function description
0	NULL	Not defined
1	RUN	When the inverter is in operation mode, the terminal output is active
2	FAR frequency arrival	Refer to P3.26 frequency arriving detection width

	Function setting	Function description
3	FDT frequency detection	See P3.27, P3.28 frequency detection value and frequency detection lag correlation description
4	FDTH upper limit frequency arrival	When Setting frequency \geq upper limit frequency and the running frequency arrives at the upper limit frequency and has delayed, the terminal output is active.
5	FDTL lower limit frequency arrival	When Set frequency \leq lower limit frequency and the running frequency reaches lower limit frequency, the terminal output is active
6	Reserve	Reserve
7	Inverter is in zero speed operation	When the output frequency of the inverter is 0, but the inverter is in operation mode, the terminal output is active
8	Simple PLC step operation completion indication	When simple PLC completes the current step operation, the terminal output is active (single pulse signal with the width of 500ms)
9	PLC cycle completion indication	When simple PLC completes one operation cycle, the terminal output is active (single pulse signal with the width of 500ms)
10	Inverter running ready (RDY)	When the inverter is at stop and can start up at any time, the terminal output is active (No fault, no running prohibition, no interruption, no reset, no free stopping, no Uu alarm, etc.)
11	Coast-to-stop	Terminal output is active during Coast-to-stop (single pulse signal with the width of 500ms)
12	Auto restart	Terminal output is active when the inverter restarts due to auto reset because of fault (single pulse signal with the width of 500ms)
13	Timing arrival	See description in "timing driving input"
14	Counting arrival output	Terminal output active after the counting arrives the set point
15	Set running time arrival	When the inverter's accumulated running time (PE.09) reaches the set running time (P3.34), the terminal output is active
16	Torque arrival detection	Torque reaches the set point, the terminal output is active, and when the it is less than 80% of the set point, terminal output is inactive
17	CL current-limit action	When the output current reaches the current amplitude limit level (Pd.09), the terminal output is active When the current amplitude limit level is less than 90%, the terminal output is inactive

	Function setting	Function description
18	Overvoltage stall	When the DC bus voltage reaches the stall overvoltage point (Pd.11), the terminal outputs active signal; when it is less than 95% of the overvoltage stall point, the terminal output is inactive
19	Inverter failure	When the inverter has a fault, the terminal output is active
20	External fault stopping (EXT)	When the inverter has an external fault tripping alarm, the terminal output is active
21	Uu1 under-voltage stopping	When the DC bus voltage is below the under-voltage set point, the terminal output is active
22	Reserve	Reserve
23	OLP2 overload pre-alarm	When the output current exceeds the overload pre-alarm action value of the inverter, the terminal output is active
24	AE1: Abnormality of analog signal 1	When the signal level of the analog signal is less than the minimum value or higher than the maximum value continuously for 500ms, the terminal output is active. (S2R4GB, S2R75GB have no AE2)
25	AE2: Abnormality of analog signal 2	
26	Reserve	Reserve
27	Reserve	Reserve
28	Reserve	Reserve
29	Sleeping	When the system is sleeping, the terminal output is active.
30	Zero speed	When the output frequency is 0, the terminal output is active
31	Reserve	Reserve
32	Reserve	Reserve
33	Actual direction of rotation	When the inverter switches the direction, the output level signal is also changed accordingly
34	Reserve	Reserve
35	Underload detection signal (ULP)	When the inverter is underload, the underload detection signal is active
36	Multi-stage speed	The output terminal is active when any "Multi-step speed" input terminal is active.
37	Control signal	The output terminal is active when the No.74 multi-function input terminal is active

Notes:

- ◆ This series of inverters have 2 ways of digital outputs, i.e. DO and relay 1, which are programmable multi-function terminals. Users may select some control and monitoring signals (shown in Table 5-3-4) based on their needs.

P3.26 Frequency arriving detection width	Setting range: 0.00~10.00 Hz [2.50Hz]
--	---------------------------------------

Notes:

- ◆ When the output frequency reaches the frequency set point, the function adjusts its detection width. The adjustment range is 0 ~ ± 10.00Hz of the set frequency.

When the inverter's output frequency is within the positive and negative detection width of the set frequency, related output terminal is active, as shown in Fig. 5-3-8.

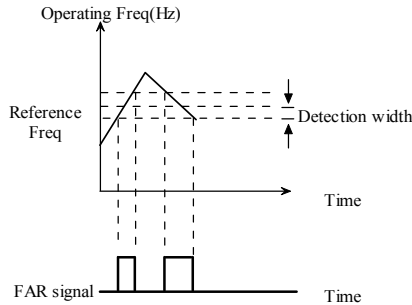

Fig. 5-3-8 FAR detection diagram

P3.27 FDT level	Setting range: 0.00~Maximum frequency [50.00Hz]
P3.28 FDT lag	Setting range: 0.00~10.00Hz [1.00Hz]

Notes:

- ◆ When the output frequency rises to a certain preset frequency (frequency detection threshold), the related terminal output will be valid. We called the preset frequency FDT level. In the dropping of output frequency, the related terminal output signal keeps on until the output frequency drops to another certain frequency below FDT level, which is called release frequency (Release frequency=FDT1 level-FDT1 lag), as shown in Fig. 5-3-9.

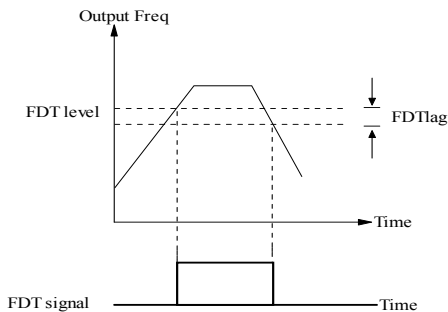

Fig. 5-3-9 Frequency detection FDT

P3.29 Upper limit Frequency arriving output delay time	Setting range: 0.0~100.0s [0.0s]
P3.30 Lower limit Frequency arriving output delay time	Setting range: 0.0~100.0s [0.0s]

Notes:

- ◆ These two functions are enabled when setting DO and relay 1 output in P3.19 ~ P3.25 option as "FDTH upper limit frequency arrival" or "FDTL lower limit frequency arrival". Typically, these two functions are set to prevent load joggling and signal instability when switching between mains frequency and inverter variable frequency in application of multiple motors, as shown in Fig. 5-3-10.

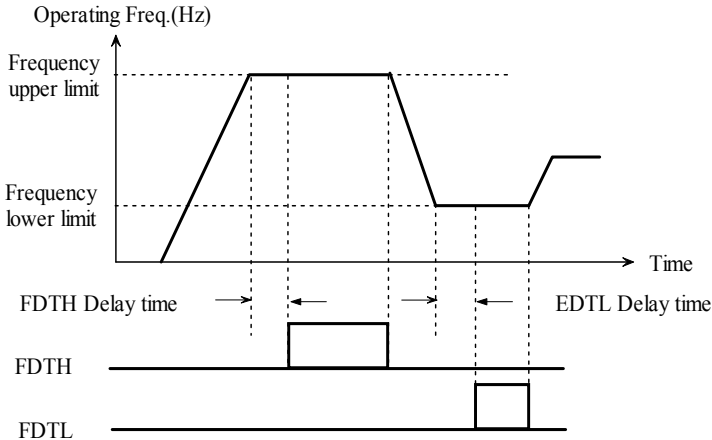

Fig. 5-3-10 FDTH/FDTL

P3.31 Torque detection setting	Setting range: 0.0~200.0% [100.0%]
--------------------------------	------------------------------------

Notes:

- ◆ If motor torque is equal to or more than the value of torque detection reference, the output of terminal is valid. If the motor torque is less than 80% of reference, the output of terminal is invalid, as shown in Fig. 5-3-11

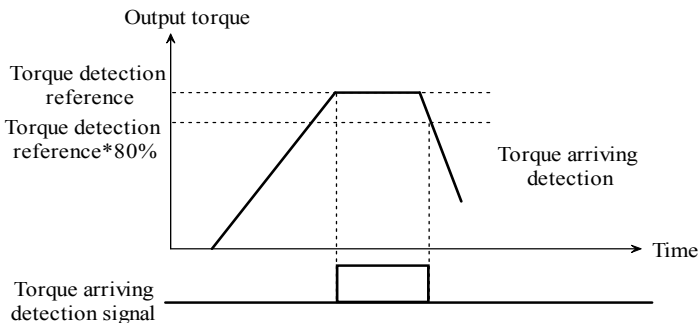

Fig. 5-3-11 Torque arriving

P3.32 Counting arriving setting	Setting range: 0~9999[0]
---------------------------------	--------------------------

Note:

- ◆ If the counting value reaches the value defined by P3.32, the output of terminal is valid, as shown in Fig. 5-3-12.

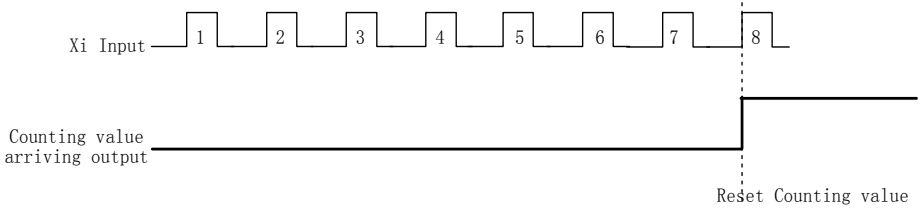

Fig. 5-3-12 Counting value arriving

P3.33 Timing arriving setting	Setting range: 0.0~6553.0 [0.0]
-------------------------------	---------------------------------

Notes:

- ◆ When the timing is equal to this value, the terminal output is active, as shown in Fig. 5-3-7.
- ◆ The unit of P3.33 timing is identified by function terminal 53; the cumulative time of timing is cleared only when terminal No.49 function is inactive, otherwise it remains.

P3.34 Preset operating time	Setting range: 0~65530h [65530]
-----------------------------	------------------------------------

Notes:

- ◆ When the total operating time reaches the preset operating time (P3.26), the output of terminal is valid.

P3.35 Underload detection setting	Setting range: 0~200.0 % [10.0 %]
-----------------------------------	--------------------------------------

P3.36 Underload detection terminal output delay time	Setting range: 0~100.0s [5.0s]
--	--------------------------------

Notes:

- ◆ P3.35 Underload detection setting 0~200.0% corresponds to 0 ~ 2 times of the rated torque. When the actual output torque is less than P3.35 set point, the terminal has signal output after the lag time defined in P3.36 if the underload detection terminal setting is active; when the torque increases and is greater than the set point of P3.35, the terminal output is inactive.

5.5 Analog and Pulse Function (Group P4)

P4.00 Analog nonlinear selection	Setting range: 0~3 [0]
----------------------------------	------------------------

- | | |
|-------------------------------------|----------|
| 0: Null | 1: AI1 |
| 2: AI2(S2R4GB, S2R75GB have no AI2) | 3: Pulse |

Notes:

- ◆ If the setting is 0, P4.01~P4.05 are used to define AI1 inputs, P4.06~P4.10 are used to define AI2 inputs, and P4.11~P4.15 are used to defined pulse inputs. They are independent and have no interference with each other.
- ◆ If the setting is not 0, it will be nonlinear selection, all the parameters from P4.01 to P4.15 are decided by the selected channel in P4.00. The filter time also follow

the selected channel setting and the physical values of the other channel are 0.

- ◆ If the setting of P4.00 is 1 or 2 (S2R4GB, S2R75GB no AI2), the selection will be analog input and the default ascending values input to this channel would be : 0.00V, 2.00V, 4.00V, 6.00V, 8.00V, 10.00V;
- ◆ If the setting is 3, the selection will be pulse input. And the default values input to the channel are: 0.00 kHz, 10.00 kHz, 20.00 kHz, 30.00 kHz, 40.00 kHz, and 50.00 kHz. The default physical quantities values are linear relation.

Tips: Only when the value of P4.00 is changed and saved by pressing the “ENTER” key, can the input channel values be initialized to the default values.

P4.01 AI1 Minimum analog input value	Setting range: 0.0~P4.03 [0.05V]
P4.02 Corresponding physical quantity of AI1 minimum analog input value	Setting range: -100.0%~100.0% [0.0%]
P4.03 AI1 maximum analog input value	Setting range: P4.01~11.00V [10.00V]
P4.04 Corresponding physical quantity of AI1 maximum analog input value	Setting range: -100.0%~100.0% [100.0%]
P4.05 AI1 Analog input filter time constant	Setting range: 0.01~50.00s [0.05s]
S21R5GB, S2R2GB, 3R75GB/31R5PB and above:	
P4.06 AI2 Minimum analog input value	Setting range: 0.00~P4.08[0.050V]
P4.07 AI2 Minimum analog input value corresponding physical value	Setting range: -100.0%~100.0%[0.0%]
P4.08 AI2 Maximum analog input value	Setting range: P4.06~11.00V[10.00V]
P4.09 AI2 Maximum analog input value corresponding physical value	Setting range: -100.0%~100.0%[100.0%]
S2R4GB, S2R75GB:	
P4.06 Nonlinear analog input value 3	Setting range: 0.00~P4.08 [0.00V]
P4.07 Corresponding physical quantity of nonlinear analog input value 3	Setting range: -100.0%~100.0% [0.0%]
P4.08 Nonlinear analog input value 4	Setting range: P4.06~10.00V [10.00V]
P4.09 Corresponding physical quantity of nonlinear analog input value 4	Setting range: -100.0%~100.0% [100.0%]
P4.11 Minimum pulse input value (pulse input terminal)	Setting range: 0.00 kHz~P4.13 [0.00kHz]
P4.12 Corresponding physical quantity of minimum pulse input value	Setting range: -100.0%~100.0% [0.0%]
P4.13 Maximum pulse input value (pulse input terminal)	Setting range: P4.11~50.00kHz [50.00kHz]
P4.14 Corresponding physical quantity of maximum pulse input value	Setting range: 0.0~100.0% [100.0%]

Note 1: (When P4.00 is set to 0)

- ◆ Min/Max value of analog input is the Min/Max virtual value of the input signals. If the actual value input is smaller than min value, the min value will be treated as

the Min virtual value of analog input. If the actual value input is greater than the max value, the max value will be treated as the Max virtual value of analog input. The max virtual value of analog input must be greater than the min one.

- ◆ Physical value corresponding to virtual value of analog input: The physical value can be reference frequency, rotate speed, or pressure, etc.
- ◆ S21R5GB, S22R2GB, 3R75GB/31R5PB and above power range inverters are provided with three groups of analog input signals: analog input terminals AI1, AI2, and pulse. S2R4GB, S2R75GB are provided with two groups of analog input signals: analog input terminals AI1 and pulse. Users can define input / output curve for each channel.
- ◆ AI1 and AI2 (S2R4GB, S2R75GB have no AI2) input signals can be 0~10V voltage signals, or 0~20mA current signals, which is selected by the users through DIP switch on the control board (DIP switch is at V position, it corresponds to 0~10V, while it is “I”, it corresponds to 0~20mA).
- ◆ Through setting P4.01~P4.04 P4.06~P4.09 and P4.11~P4.14 users can define two characteristic linear curves. The positive and negative function is shown in Fig. 5-4-1.

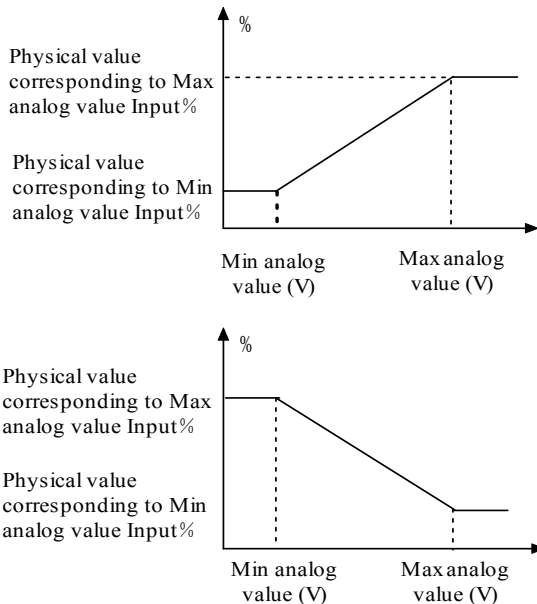

Fig. 5-4-1 Analog input linear curve

Note 2:

- ◆ When P4.00 is set to 1, 2(S2R4GB, S2R75GB have no AI2) or 3, the function of P4.01~P4.04, P4.06~P4.09 and P4.11~P4.14 are different to Note 1. User can define their own nonlinear curves by setting these parameters. Six points can be set on the curve. As shown in Fig. 5-4-2. In addition, the setting value to P4.01, P4.03, P4.06, P4.08, P4.11 and P4.13 must increase in order.

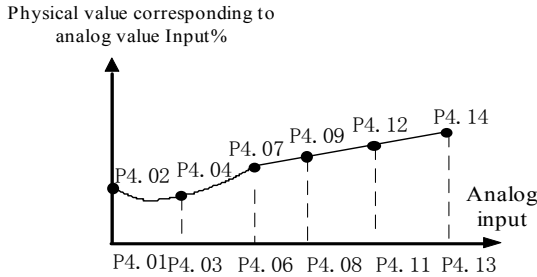

Fig. 5-4-2 Analog input non-linear curve

Note 3:

- ◆ The input filter time constant is used for digital filter of the input signal to avoid interference of the system.
- ◆ The bigger the filter time constant, the higher the immunity level and the longer the response time is. On the contrary, the smaller the time constant, the shorter the response time and the lower the immunity level is. If the best setting is not clear, you can adjust setting value according to the status of control stability and response delay time.

P4.21 AO1 function definition	Setting range: 0~14 [0]
P4.24 DO function definition	Setting range: 0~14 [0]
0: NULL	1: Output current (0~2I _N)
2: Output voltage (0 ~ maximum voltage)	3: PID setting (0 ~ 10V)
4: PID feedback (0 ~ 10V)	5: Calibration signal (5V)
6: Output torque (0 ~ 2 times of the rated motor torque)	7: Output power (0 ~ 2 times of the rated motor power)
8: Bus voltage (0 ~ 1000V)	9: AI1 (0~10V / 0~20mA)
10: AI2: 0~10V (S2R4GB, S2R75GB have no AI2)	11: Reserve
12: Output frequency before compensation (0 ~ maximum frequency)	13: Output frequency after compensation (0 ~ maximum frequency)
14: Current speed (0 to 2 times of the rated speed)	

Notes:



- ◆ This series of inverters are provided with 1 way of analog signal output. The output signal is analog voltage with the full range of DC 10V. The output content is selected by the users. The pointer full-scale can be adjusted based on the actual needs.

P4.25 AO1 output range selection	Setting range: 0, 1 [0]
0: 0~10V/0~20mA	1: 2~10V/4~20mA
P4.28 AO1 gain	Setting range: -10.00~10.00 [1.00]

Notes:

- ◆ Inverter output signals and user instrumentation system may produce errors, if the

user needs to calibrate the instrument display error or change the instrument display range, AO1 gains can be defined for adjustment.

- ◆ In order to avoid fluctuations in the output data during adjustment, the system can be set to output standard calibrated signals (set values of P4.21 to 5, DC5V output (50% of the full scale) is obtained) to adjust AO* gain. When adjusting AO1, enter function code P4.28, rotate the knob  or  to make the output signal be 5V, it will takes effect immediately after modifying the value of function code P4.28, then save by pressing Enter key.
- ◆ If the peripheral instruments have large errors, then it is necessary to connect instrumentation for actual calibration.

P4.31 AO1 offset	Setting range: -100%~100% [0.0%]
------------------	----------------------------------

Notes:

- ◆ If the offset is represented by "b", the gain is represented by "k", the actual output is represented by "y", the standard output is represented by "x", the actual output is $y = kx + 10 b$; AO1 offset 100 % corresponds to 10V. Standard output means 0 to maximum value of the corresponding analog output when the output is 0 ~ 10V. It is generally used to correct null shift of analog output and derivation of the output amplitude. It can also be customized to any desired output curve. For example: If the analog output is running frequency, and it is desired to output 8V when the frequency is 0 and to output 3V when the frequency is maximum, then the gain should be set to "-0.50", the offset should be set to "80%".

P4.34 Max output frequency of DO	Setting range: P4.35~50.00kHz [10.00kHz]
P4.35 Min output frequency of DO	Setting range: 0.00kHz ~P4.34 [0.00kHz]

5.6 PLC Operating (Group P5)

P5.00 PLC Operating mode	Setting range: 0~2[2]
--------------------------	-----------------------

- 0: Single cycle 1
- 1: Single cycle 2 (holding the final value)
- 2: Continuous operation

Notes:

- ◆ Single cycle 1
The inverter stops automatically after one cycle of operation and will start when receiving RUN command again. As shown in Fig. 5-5-1.

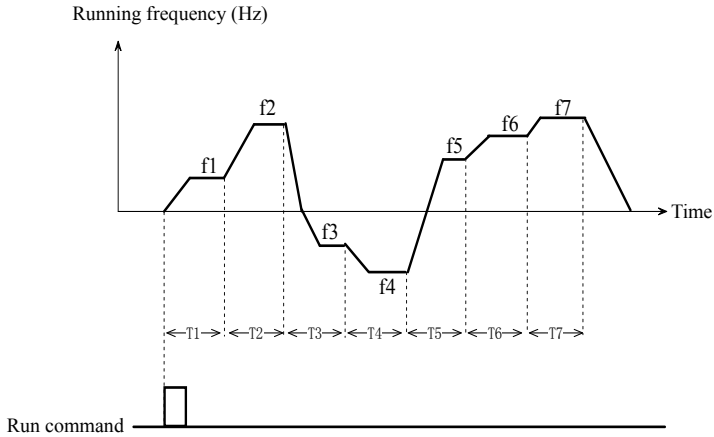

Fig. 5-5-1 Stop mode after single cycle of PLC

- ◆ Single cycle 2 (holding the final value)
The inverter will hold the operating frequency and direction of last step after completing one cycle of operation. As shown in Fig. 5-5-2

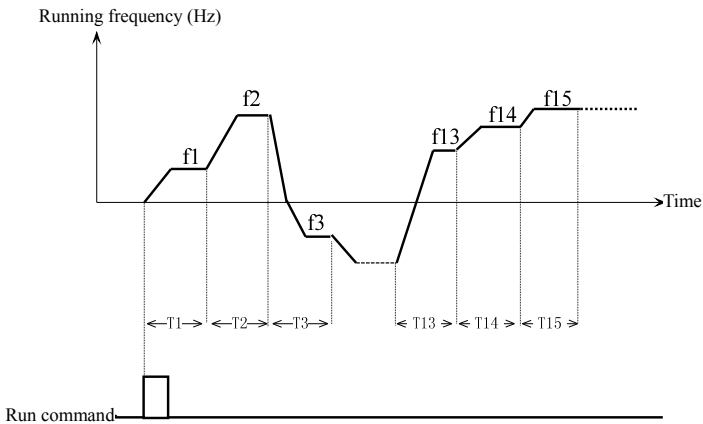

Fig. 5-5-2 Holding the frequency after single cycle

- ◆ Continuous operation
The inverter will start next cycle of operation automatically after completing one cycle of PLC operation until receiving stop command, fault alarm, or power failure. As shown in Fig. 5-5-3.

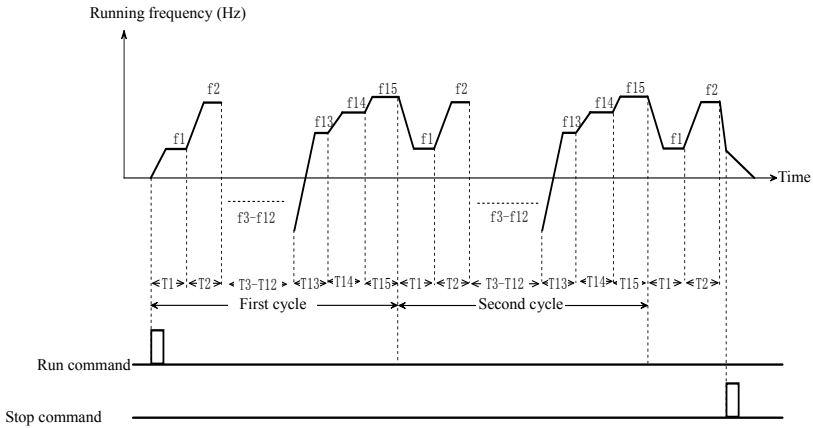

Fig. 5-5-3 Continuous operation of PLC

P5.01 PLC restarting mode selection	Setting range: 0~2 [0]
-------------------------------------	------------------------

0: Restart from first step

1: Continue from the step where the inverter stops

2: Continue to operate at the frequency when the inverter stops

Notes:

- ◆ Restart from first step
If the inverter stops during PLC operation because of receiving stop command or fault, or power loss, it will restart from the first step after restarting.
- ◆ Continue from the step where the inverter stops
When the inverter stops during PLC operation because of receiving stop command or fault, it will record the operating time and will continue from the step where the inverter stops. It restarts at the frequency defined for this step and run the left time of this step, as shown in Fig. 5-5-4

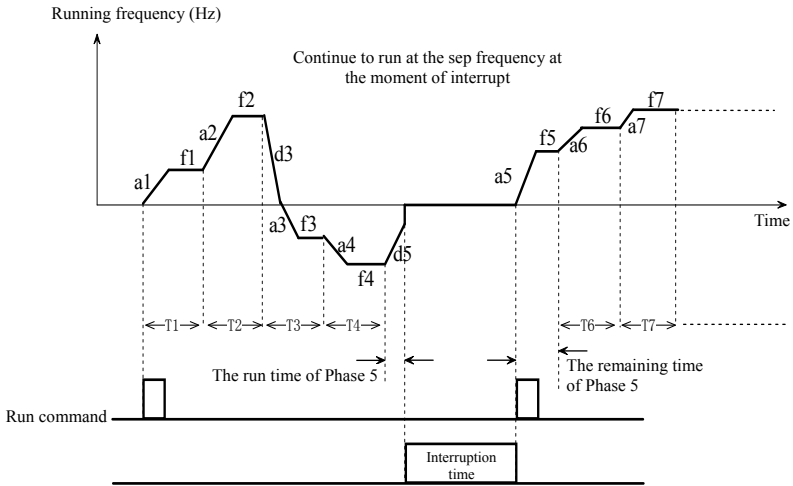

Fig. 5-5-4 PLC start mode 1

- ◆ Continue to run at the operation frequency at the moment of interrupt
 When the inverter stops during PLC operation, the inverter not only automatically records the run time of the current phase, but also records the running frequency at the time of stopping. The inverter will restore to the running frequency at the time of stopping when restarting, and then continue the operation in the remaining phases, as shown in Fig. 5-5-5.

Tips:

The difference between way 1 and 2 lies in that way 2 stores the running frequency at the time of stopping, and the inverter continues to run from this frequency.

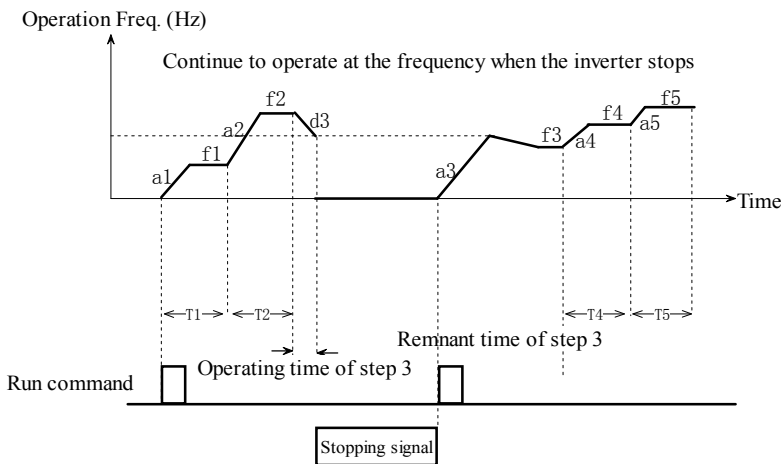

Fig. 5-5-5 PLC start mode 2

P5.02 PLC power failure record selection	Setting range: 0, 1 [0]
--	-------------------------

0: Not save

1: Save

Notes:

- ◆ Not save
The inverter does not save the PLC operating state when the power is off and restart from the first step after the power is on.
- ◆ Save: Inverter records PLC running state at the time of power failure, including running step, operating frequency, and the operating time. And it will restart in the way defined in P5.01 after power recovery.

P5.03 PLC operating time unit selection	Setting range: 0, 1 [0]
---	-------------------------

0: Second

1: Minute

Notes:

- ◆ This unit is only valid for defining the PLC operating time. The unit of Acc/Dec time in PLC operation is still second.

P5.04 PLC operating Timing T1	Setting range: 0.1~3600 [10.0]
P5.05 PLC operating Timing T2	Setting range: 0.0~3600 [10.0]
P5.06 PLC operating Timing T3	Setting range: 0.0~3600 [10.0]
P5.07 PLC operating Timing T4	Setting range: 0.0~3600 [10.0]
P5.08 PLC operating Timing T5	Setting range: 0.0~3600 [10.0]
P5.09 PLC operating Timing T6	Setting range: 0.0~3600 [10.0]
P5.10 PLC operating Timing T7	Setting range: 0.0~3600 [10.0]
P5.11 PLC operating Timing T8	Setting range: 0.0~3600 [10.0]
P5.12 PLC operating Timing T9	Setting range: 0.0~3600 [10.0]
P5.13 PLC operating Timing T10	Setting range: 0.0~3600 [10.0]
P5.14 PLC operating Timing T11	Setting range: 0.0~3600 [10.0]
P5.15 PLC operating Timing T12	Setting range: 0.0~3600 [10.0]
P5.16 PLC operating Timing T13	Setting range: 0.0~3600 [10.0]
P5.17 PLC operating Timing T14	Setting range: 0.0~3600 [10.0]
P5.18 PLC operating Timing T15	Setting range: 0.0~3600 [10.0]

Notes:

- ◆ Define operating time of each step during the PLC Operating, the operating time varies from 0.0 to 3600 s (if P5.03 is set to min, the unit is min), it is continuous and adjustable. When running time is set to 0, the speed of this step is skipped, the inverter will run at the speed of next step.

P5.19 Step T1 operating setting of PLC	Setting range: 1F~4r [1F]
P5.20 Step T2 operating setting of PLC	Setting range: 1F~4r [1F]
P5.21 Step T3 operating setting of PLC	Setting range: 1F~4r [1F]
P5.22 Step T4 operating setting of PLC	Setting range: 1F~4r [1F]
P5.23 Step T5 operating setting of PLC	Setting range: 1F~4r [1F]

P5.24 Step T6 operating setting of PLC	Setting range: 1F~4r [1F]
P5.25 Step T7 operating setting of PLC	Setting range: 1F~4r [1F]
P5.26 Step T8 operating setting of PLC	Setting range: 1F~4r [1F]
P5.27 Step T9 operating setting of PLC	Setting range: 1F~4r [1F]
P5.28 Step T10 operating setting of PLC	Setting range: 1F~4r [1F]
P5.29 Step T11 operating setting of PLC	Setting range: 1F~4r [1F]
P5.30 Step T12 operating setting of PLC	Setting range: 1F~4r [1F]
P5.31 Step T13 operating setting of PLC	Setting range: 1F~4r [1F]
P5.32 Step T14 operating setting of PLC	Setting range: 1F~4r [1F]
P5.33 Step T15 operating setting of PLC	Setting range: 1F~4r [1F]

Notes:

- ◆ Specify the acceleration and deceleration time and the running direction of the inverter at each step. There are eight combinations with the meanings shown in Table 5-5-1.

Table 5-5-1 PLC program run setup description

Symbol	Acc/Dec time		Direction
1F	Acc/Dec time 1	P0.18, P0.19	F: Forward
1r			r: Reverse
2F	Acc/Dec time 2	P2.28, P2.29	F: Forward
2r			r: Reverse
3F	Acc/Dec time 3	P2.30, P2.31	F: Forward
3r			r: Reverse
4F	Acc/Dec time 4	P2.32, P2.33	F: Forward
4r			r: Reverse

P5.34 PLC operating record clearing	Setting range: 0, 1 [0]
P5.35 PLC operating step record	Setting range: 0~15 [0]
P5.36 Operating time of current step	Setting range: 0.0~3600 [0.0]

Notes:

- ◆ PLC operating step record (P5.35) records the step that the PLC currently operating at.
- ◆ Operating time of current step (P5.36) records the operating time of the step that the PLC currently operating at.
- ◆ When P5.34 is set to 1, clear record of PLC operating steps (P5.35), and operating time of this step (P5.36). P5.34 restores to 0 after clearing.

Tips:

You can start, pause, and reset PLC operating by setting external terminal function, which is defined in Group 3.

5.8 PID Control (Group P7)

P7.00 PID setting source 1	Setting range: 0~5 [0]
----------------------------	------------------------

P7.01 PID setting Source 2	Setting range: 0~5 [0]
0: PID digital setting	1: Terminal AI1
2: AI2 terminal(S2R4GB, S2R75GB have no AI2)	3: Reserve
4: Pulse input	5: Serial communication
P7.02 Combination of PID setting	Setting range: 0~7 [0]
0: PID setting by source 1 only	1: PID setting by source 2 only
2: Min (PID setting by source 1, PID setting by source 2)	3: Max (PID setting by source 1, PID setting by source 2)
4: PID setting by source 1+PID setting by source 2	5: PID setting by source 1-PID setting by source 2
6: PID setting by source 1*PID setting by source 2	7: PID setting by source 1/PID setting by source 2

Notes:

- ◆ It is used to determine the PID giving quantity input manner and passage. It can either be the digital quantity setting (0 or 5), or the Analog setting (1, 2(S2R4GB, S2R75GB have no AI2), 4). The digital quantity setting is more precise and stable. The Analog input curve can be set via P4 group.
- ◆ When the PID digital setting is selected as the given source, there can be two sources, i.e. the analog PID digital giving P7.06 and the speed PID giving P7.08. When the feedback quantity is the speed signal, it is the speed PID mode and P7.08 is the PID digital giving. When the feedback quantity is other signals, it is the analog PID mode and P7.06 is the PID digital giving.
- ◆ When the given source is AI1 or AI2 (S2R4GB, S2R75GB have no AI2), it is required to set the voltage or current signal to be input, which is illustrated in “2.4 Control Circuit Connection”.
- ◆ When the given source is the serial communications setting, setting is carried out by the upper computer through RS485 serial communications. If it is the analog PID, setting should be carried out according to the range percentage. If it is rotating speed PID, setting should be carried out based on the percentage corresponding to the maximum rotating speed.

P7.03 PID feedback source 1	Setting range: 0~5 [0]
P7.04 PID feedback source 2	Setting range: 0~5 [0]
0: Built-in PG or single phase speed measurement input (P7.03)	
0: Reserve (P7.04)	
1: Terminal AI1	2: AI2 terminal(S2R4GB, S2R75GB have no AI2)
3: Reserve	4: Pulse input
5: Serial communication	
P7.05 Combination of PID feedback	Setting range: 0~5 [0]
0: PID feedback by source 1 only	1: PID feedback by source 2 only
2: Min (PID feedback by source 1, PID feedback by source 2)	3: Max (PID feedback by source 1, PID feedback by source 2)

4: PID feedback by source 1+PID
feedback by source 2

5: PID feedback by source 1-PID
feedback by source 2

Notes:

- ◆ It is used to determine the PID feedback input mode and channel. 0: represents to choose the rotation speed PID. When the given is the Analog, the given speed is converted proportionally with maximum rotation speed (the rotational speed corresponding to maximum frequency) corresponding to the full scale. Others: represent to select the analog PID.
- ◆ AI1 terminal, AI2terminal(S2R4GB, S2R75GB have no AI2), pulse input, and serial communication description is the same as that for setting source.
- ◆ PG or single phase speed input: use speed PID control of pulse encoder PG. X5 must be defined as speed measurement.

P7.06 Analog PID digital giving	Setting Range: -P7.07~P7.07 [0.0]
P7.07 Analog PID given range	Setting Range: MAX (1.0, P7.06)~1000.0 [100.0]

Notes:

- ◆ When analog feedback is adopted, this function realizes the digital giving by keypad. The value is the actual physical quantity and should match with the range.
- ◆ Setting and feedback quantity of the analog PID should take this as the benchmark and should be consistent with the actual quantity.

P7.08 Speed PID digital setting	Setting range: 0~24000rpm [0rpm]
---------------------------------	----------------------------------

Notes:

- ◆ When PG impulse feedback is adopted, the given value of rotating speed will be set via the keypad. When the speed PID given range is over 10000, it will be indicated by “1000.”.

P7.09 PID proportional gain1	Setting Range: 0.1~30 [1.0]
P7.10 PID integration time 1	Setting Range: 0.00~100.0s [3.00s]
P7.11 PID derivative time1	Setting Range: 0.00~1.00s [0.00s]
P7.12 Switching frequency1	Setting Range: 0.00~switching frequency 2 [5.00Hz]
P7.13 PID proportional gain2	Setting Range: 0.1~30 [1.0]
P7.14 PID integration time 2	Setting Range: 0.00~100.0s [3.00s]
P7.15 PID derivative time2	Setting Range: 0.00~1.00s [0.00s]
P7.16 Switching frequency 2	Setting Range: switching frequency1~max. frequency [20.00Hz]

Notes:

- ◆ Proportional gain is the parameter determining the response degree of proportional action to deviation. When a large value is taken for the proportional gain, the system will act sensitively and the response will be accelerated. However, if the value is a little larger, the oscillation times will be increased and the adjustment time will be extended; if it is too large, the system will tend to be

unstable; when it is too small, the system will act slowly and the response will be delayed.

- ◆ The integration time is used to determine the integration action effect. When the integration time is long, the response will be slow. In addition, the control ability for the external disturbance will be weaker. When the integration time is short, the integration action will be strong, the steady-state-errors will be eliminated, the system control precision will be promoted, and the response speed will be quick. If the integration time is too short, oscillation will occur and the system stability will be reduced.
- ◆ The differential time determines the differential action effect. When the differential time is long, oscillation caused by the P action in the case of deviation will be attenuated quickly and the adjustment time will be short. However, if the differential time is too long, oscillation will be caused on the contrary. When the differential time is short, the attenuation action will be small and the adjustment time will be longer in the case of deviation. The adjustment time can only be reduced when the differential time is appropriate.

P7.17 Differential object selection	Setting Range: 0, 1 [0]
1: Feedback Differentiation	2: Deviation Differentiation
P7.18 PID integral amplitude limit	Setting Range: 0.0~100.0% [20.0%]
P7.19 PID differential amplitude limit	Setting Range: 0.0~100.0% [5.0%]
P7.20 PID output amplitude limit	Setting Range: 0.0~100.0% [100.0%]

Notes:

- ◆ The above limits are all based on the 100% maximum output frequency.

P7.21 PID delay time constant	Setting range: 0.00~25.00s [0.00s]
-------------------------------	------------------------------------

Notes:

- ◆ PID-controlled Frequency Command Output Delay Time Setting

P7.22 Error margin	Setting range: 0.0~999.9 [0.0]
--------------------	--------------------------------

Notes:

- ◆ If the difference between feed and feedback value is smaller than Error margin, PID regulation will stop and the inverter maintains the present output. As shown in Fig. 5-7-1.
- ◆ Setting this parameter correctly is helpful to balance the system output accuracy and stability. The error margin reduces the regulation accuracy of the system, but improves the system stability, to avoid unnecessary fluctuations of output.
- ◆ In the case of analog PID, the error margin sets P7.22 as the absolute value of physical quantity, which should match with the range. In the case of speed PID, the error margin sets P7.22 as the rotating speed. It is showed in Fig. 5-7-1:

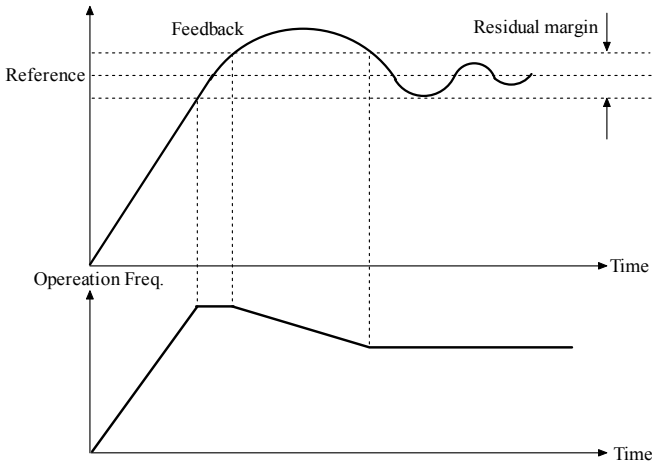

Fig. 5-7-1 Residual margin diagram

P7.23 PID adjustment characteristic	Setting range: 0, 1 [0]
-------------------------------------	-------------------------

0: Positive Action

1: Negative Action

Notes:

- ◆ Positive: When the PID output increases, the output frequency will increase and the controlled physical value will increase, such as water supply.
- ◆ Negative: When the PID output increases, the output frequency will increase, but the controlled physical value will decrease, such as refrigeration system.

P7.24 Integral adjustment selection	Setting range: 0, 1 [0]
-------------------------------------	-------------------------

0: When the frequency reaches the upper or lower limit, the integral adjustment will be stopped.

1: When the frequency reaches the upper or lower limit, the integral adjustment will be continued.

Tips:

0 is suggested for the system requiring the rapid response. When the frequency reaches the upper or lower limit, the integral adjustment will be stopped.

P7.25 Sleep selection	Setting range: 0, 1 [0]
-----------------------	-------------------------

0: Disable

1: Enable

Tips:

In the case of rotating speed PID, there is not the function of sleep.

P7.26 Sleep delay	Setting range: 0~999s [120s]
-------------------	------------------------------

P7.27 Sleep threshold	Setting range: 0~ upper limit frequency [20.00Hz]
-----------------------	---

P7.28 Wake-up threshold	Setting range: 0.0~999.9 [3.0]
-------------------------	--------------------------------

Notes:

- ◆ The function is used to stop the variable pump (all auxiliary pumps are stopped)

when the flow is zero. In this case, if the frequency of the variable pump is lower than the “sleep threshold parameter”, delay will be initiated.

- ◆ If the frequency is still lower than the threshold after the delay, the variable pump will stop. Thus, the whole equipment will be in the state of “sleep”.
- ◆ The pressure feedback should be reduced to the “wakeup” threshold to switch to the “wakeup” state. Then, the variable pump will be started (as showed in Fig. 5-7-3). The wakeup threshold setting range corresponds to the analog PID feedback percentage.

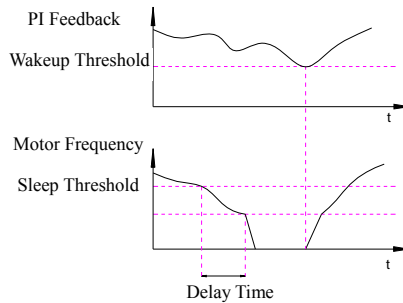

Fig. 5-7-3 Sleep & Wakeup

P7.29 PID Feedforward coefficient	Setting range: 0.5000~1.024 [1.000]
-----------------------------------	-------------------------------------

Notes:

- ◆ When the adjusting overshoot is large, the parameter can be reduced appropriately.

P7.30 Selection of KP processing mode and slow start within deviation range	Setting range: 0~255[00]
---	--------------------------

Unit's: 0: not process KP within deviation range

Ten's: 0: not use slow start function

1: dynamic KP within deviation range

1: within deviation range1

2: solid KP within deviation range

2: within deviation range2

P7.31 KP value lower limit	Setting range: 0.01~2.55[0.06]
----------------------------	--------------------------------

P7.32 KP value during slow start period	Setting range: 0.01~30.00[0.10]
---	---------------------------------

P7.33 Slow start keeping time	Setting range: 0.1~999.9s[10.0s]
-------------------------------	----------------------------------

Note:

- ◆ Unit's place of P7.30:
 Select 0: not process KP within deviation range;
 Select 1: When deviation less than P7.22 (deviation permission) setting range, KP will adjust automatically for stable running. The minimum value of KP is the setting value of P7.31;
 Select 2: When deviation less than P7.22 (deviation permission) setting range, KP will use the setting value of P7.31.
- ◆ Ten's place of P7.30:

0: Slow start function is invalid;

1: Slow start function is valid, and you have to set P7.33. During slow start KP will not be processed;

2: Slow start function is valid, and you have to set P7.32 and P7.33. If the overshoot is big, decrease P7.32, and increase P7.32 when the system acts slowly.

5.9 Vector Control Mode (Group P8)

Notes: S2R4GB or S2R75GB has no SVC, parameters of “Group P8” can’t be changed.

P8.00 Pre-excitation current compensation quantity	Setting range: 0.0~500.0% [100.0%]
--	------------------------------------

Notes:

- ◆ The 100.0% is corresponding to motor no-load current. The action time is set in the P1.04. The actual upper limit is the smaller one between inverter 80% rated current and motor rated current.

P8.01 Speed loop proportional gain 1	Setting range: 0.1~30.0 [2.0]
P8.02 Speed loop integral time 1	Setting range: 0.001~10.000s [Depend on model]
P8.03 Switching frequency 1	Setting range: 0.00Hz~Switching frequency 2 [10.00Hz]
P8.04 Speed loop proportional gain 2	Setting range: 0.1~30.0 [1.0]
P8.05 Speed loop integral time 2	Setting range: 0.001~10.000s [Depend on model]
P8.06 Switching frequency 2	Setting range: Switching frequency 1 ~Maximum frequency [80.00Hz]

Notes:

- ◆ The P8.01 and P8.02 are PI adjustment parameters when the operation frequency is less than the switching frequency 1 (P8.03). P8.04 and P8.05 are PI adjustment parameters when the operation frequency is greater than the switching frequency 2 (P8.06). PI parameter between the switching frequency 1 and the switching frequency 2 is linear with switching of the two groups of PI parameters, as shown in Fig. 5-8-1.

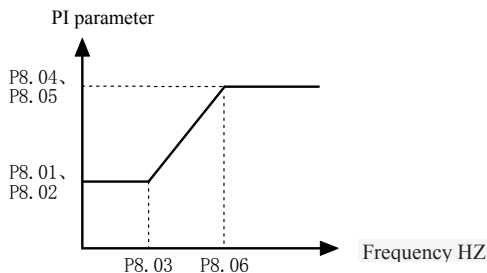

Fig. 5-8-1 PI parameters schematic diagram

- ◆ You can adjust the speed dynamic response characteristics of vector control by setting the speed regulator proportional coefficient and integral time. Increase the proportion gain or reduce the integration time can accelerate the speed loop dynamic response. If proportional gain is too large or integral time is too small, it may make the system oscillation.
- ◆ The proposed regulation method: If the factory parameters cannot meet the requirements, then adjust based on the factory value parameters: first increase the proportion gain, guarantee system not oscillation; then reduce integration time, let the system has fast response, small overshoot.

Tips:

If the PI parameter is not set appropriately, it may lead to speed overshoot too big. Even it produces overvoltage failure when the overshoot falls.

P8.07 Speed loop filtering time	Setting range: 0.000s~0.100s [0.030s]
---------------------------------	---------------------------------------

Explanation:

- ◆ In the vector control mode, the output of the speed loop regulator is torque current command. The parameters are used for the torque command filter. The parameters require no adjustment in general. When the speed fluctuation is big, it may appropriately increase the filtering time. If the motor has oscillation, it should appropriately reduce the parameter.
- ◆ If the speed loop filter time constant is small, the inverter output torque may change greatly, but the response is fast.

P8.08 Speed loop filter time estimation	Setting range: 1.0~20.0ms [1.0ms]
---	-----------------------------------

Notes:

When the system operating noise is large or the system oscillates at one speed, the parameter can be increased appropriately.

P8.09 Feed forward coefficient of speed loop	Setting range: 0.500~1.024 [1.000]
--	------------------------------------

Notes:

- ◆ When the speed overshoot is large, the parameter can be reduced appropriately.

P8.10 Torque control mode	Setting range: 0~2 [0]
---------------------------	------------------------

- 0: Operation according to the speed control mode
- 1: Operation according to the torque control mode
- 2: Operation according to the torque motor mode

Notes:

- ◆ When the setting is 0, the inverter outputs according to the setting frequency. The output torque matches with the load torque automatically, but the output torque is limited by the torque upper limit. When the load torque is larger than the setting torque upper limit, the inverter output torque is limited. The output frequency is different from the setting frequency.
- ◆ When the setting is 1, inverter outputs according to the setting torque. At this time, the output frequency automatically matches with the load speed, but limited

by the Upper frequency limit. When the load speed is greater than the upper limit frequency, the inverter output frequency is limited. The output torque is different from the setting torque.

- ◆ When in torque control, torque command is the torque upper limit, which is set by the torque upper limit source. You can switch through multifunction input terminal between torque and speed mode. When in torque control, the inverter output automatically tracks load speed changes, but the output frequency change speed is influenced by the setting acceleration and deceleration time. If it needs accelerate tracking speed, you should shorten Acc./Dec. time. When the setting torque of the inverter is greater than the load torque, the inverter output frequency will rise. When the inverter output frequency reaches the upper limit frequency, inverter will be operated at upper limit frequency. When the setting torque of the inverter is less than the load torque, the inverter output frequency will decrease, but not limited by the lower frequency limit.
- ◆ When the setting is 2, inverter operates according to the torque motor mode. The main feature of the torque motor is soft mechanical property of rotor stalling. When the load torque increases, it can automatically reduce the speed.

P8.11 Driving torque upper limit setting source	Setting range: 0~5 [0]
0: Digital setting 2: AI2 (S2R4GB and S2R75GB do not have AI2) 4: Pulse input	1: AI1 3: Reserve 5: Serial communication
P8.12 Upper Limit of Driving Torque	Setting range: G Type: 0.0%~200.0%[160.0%] P Type: 0.0%~150.0%[130.0%]
P8.13 Upper Limit of Braking Torque	Setting range: G Type: 0.0%~200.0%[160.0%] P Type: 0.0%~150.0%[130.0%]

Notes:

- ◆ If the driving torque source is digitally set, P8.12 and P8.13 setting will be the actual torque values.

P8.14 Command Slip Compensation Factor	Setting range: 0.0%~200.0% [102.4%]
--	-------------------------------------

Notes:

- ◆ With the vector control manner, the parameter makes compensation for the torque command. The output current can be changed by revising the parameter. Generally, revision is not suggested.

P8.15 Torque acceleration time	Setting range: 0.00~120.0s [0.50s]
P8.16 Torque deceleration time	Setting range: 0.00~120.0s [0.50s]

Notes:

- ◆ Set the torque acceleration and deceleration time in torque mode. This function is invalid in the speed mode.
- ◆ The time that torque rising from 0 to rated torque is torque acceleration time. The time from rated torque to 0 is torque deceleration time

P8.17 Estimated low speed slip compensation gain	Setting range: 50.0%~200.0% [130.0%]
--	---

Notes:

- ◆ For the sensor-less vector control, if the load operation is unstable at the low speed, the parameter can be increased appropriately.

P8.18 Estimated high speed slip compensation gain	Setting range: 50.0%~200.0% [117.0%]
---	---

Notes:

- ◆ For the sensor-less vector control, the parameter is used to adjust the stable-speed precision of motor: if the speed is lower when the motor is loaded, the parameter should be increased; if the speed is higher, the parameter should be reduced.

P8.23 Zero-speed torque boosting	Setting range: 0.0~50.0% [0.0%]
P8.24 Zero-speed threshold	Setting range: 0~20% [5%]

Notes:

- ◆ P8.23 zero-speed torque boosting is to provide the additional output torque at the startup, so the motor can overcome the static friction and start smoothly when the set torque is small.
- ◆ The zero-speed threshold setting range corresponds to the 0~20% maximum output frequency.

P8.25 Braking Torque Setting Source	Setting Range: 0~5 [0]
0: Same as final driving torque value calculated in P8.11	1: AI1
2: AI2 (S2R4GB and S2R75GB do not have AI2)	3: Reserve
4: Pulse Input	5: Serial Communications

P8.26 High-speed Torque supplement	Setting range: 40.0~160.0% [100.0%]
P8.27 High-speed Torque supplement reference	Setting range: 0~2 [0]

- 0: the operation frequency
- 1: the linear speed (Reserved)
- 2: the load inertia

Notes:

- ◆ As the operation speed increases, the mechanical system will consume more and more torque, and the high-speed torque supplement is to make up for the torque consumed by the mechanical system to keep basically unchanged the torque gained by the effective load.
- ◆ What P8.26 sets is the maximum supplement and 100.0% corresponds to the rating output torque of motor. When the supplement is according to the operation

frequency, the relationship between the torque supplement and the present operation frequency is showed in Fig. 5-8-2:

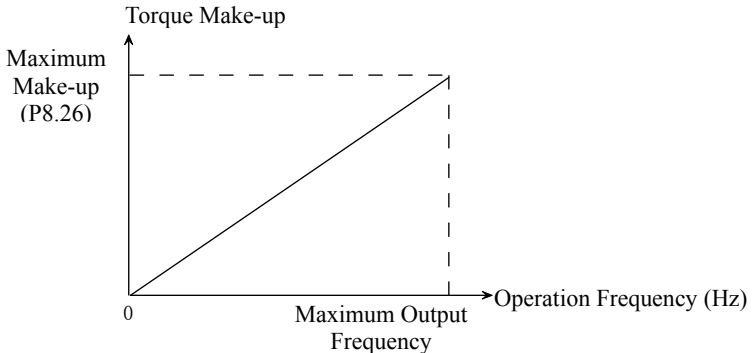

Fig. 5-8-2 Relationship between the High-speed Torque supplement and the Output Frequency

P8.28 Pre-excitation Time	Setting Range: 0.05~3.00s [0.10s]
---------------------------	-----------------------------------

Notes:

- ◆ The function of pre-excitation is used to establish the magnetic field before the asynchronous motor starts. The parameter sets the duration time of this process.

5.10 V/F Control (Group P9)

P9.00 V/F curve setup	Setting range: 0~4 [0]
-----------------------	------------------------

- 0: Constant Torque Characteristic Curve 0
 1: Variable Torque Characteristic Curve 1 (2.0)
 2: Variable Torque Characteristic Curve 2 (1.5)
 3: Variable Torque Characteristic Curve 3 (1.2)
 4: User defined V/F curve(determined by P9.01 ~ P9.06)

P9.01 V/F frequency F1	Setting range: 0.0~P9.03 [10.00Hz]
P9.02 V/F voltage V1	Setting range: 0~100.0% [20.0%]
P9.03V/F frequency F2	Setting range: P9.01~P9.05 [25.00Hz]
P9.04 V/F voltage V2	Setting range: 0~100.0% [50.0%]
P9.05 V/F frequency F3	Setting range: P9.03~P0.09 [40.00Hz]
P9.06 V/F voltage V3	Setting range: 0~100.0% [80.0%]

Notes:

- ◆ This group of function codes defines the flexible V/F setting manner of the series inverter to satisfy the different load characteristic needs.

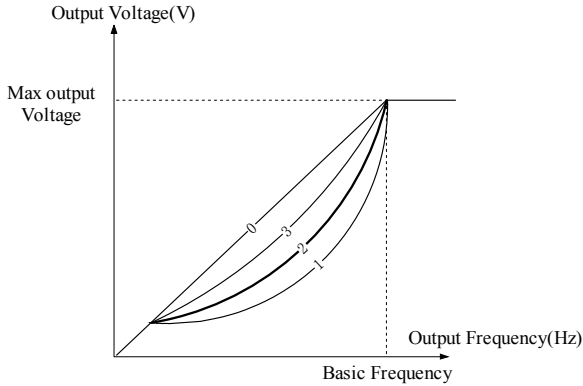

Fig. 5-9-1 Torque-reducing curve

- ◆ When 4 is selected for P9.00, the user can self-define the V/F curve through P9.01~P9.06. As showed in Fig. 5-9-2, the V/F curve is defined with the four-point broken line to be adapted for the special load characteristics.
- ◆ Notes: $V1 < V2 < V3$. In the case of low frequency, if the voltage is set to be too high, the motor may be overheated and even burned, and the inverter may stall over current or be over-current protected.

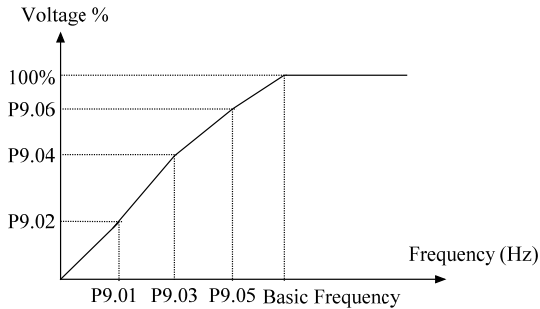

Fig. 5-9-2 V/F-curve defined by user

P9.07 Torque boost	Setting range: 0.0~30.0% [0.0%]
--------------------	---------------------------------

Notes:

- ◆ To improve the low-frequency torque characteristic, certain boost compensation can be made for the output voltage. When the function code is set as 0.0%, it is at the V/F control mode; when it is not set as 0, it is at the manual torque boost mode, as showed in Fig. 5-9-3.

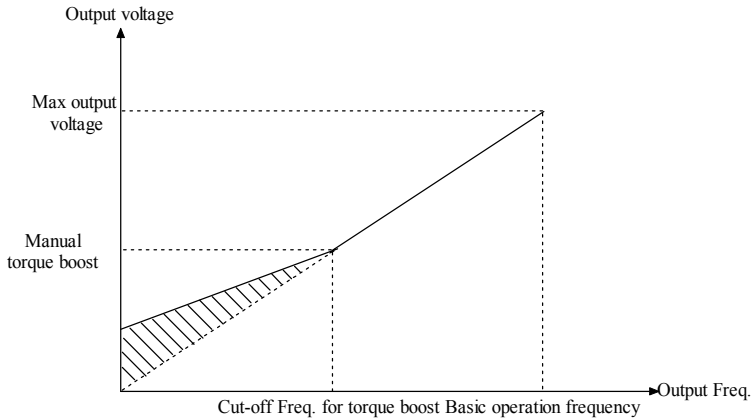

Fig. 5-9-3 Manual Torque Boost

Tips:

1. Wrong parameter setting can cause overheat or over-current protection of the motor.
2. When the inverter drives synchronous motor, manual torque boost function is recommended and V/F curve should be adjusted according to the motor parameters and application features.

P9.08 Cut-off frequency of manual torque boost	Setting range: 0.00~50.00Hz [16.67 Hz]
--	--

Notes:

- ◆ This function defines the cutoff frequency for manual torque boost as showed in Fig. 5-9-3. The cutoff frequency is applicable to any V/F curve determined by P9.00.

P9.09 Slip compensation coefficient	Setting range: 0.0~250.0% [0.0%]
P9.10 Slip compensation time constant	Setting range: 0.01~2.55S [0.20S]

Notes:

- ◆ The motor's slip changes with the load torque, which results in the variance of motor speed. The inverter output frequency can be adjusted automatically through slip compensation according to the load torque. Therefore, the electrical characteristics of the mechanical hardness are improved. As shown in Fig. 5-9-4.

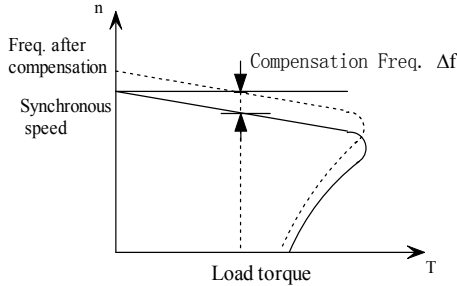

Fig. 5-9-4 Auto slip compensation diagram

- ◆ In the case of rated torque, the slip compensation value is equal to compensation gain (P9.09) * rated slip (synchronous rotating speed –rated rotating speed);
- ◆ Motoring state: when the actual rotating speed is lower than the given speed, the compensation gain (P9.09) should be increased gradually;
- ◆ Regenerative state: when the actual rotating speed is higher than the given speed, the compensation gain (P9.09) should be increased gradually.

Tips:

The automatic slip compensation is related to the rated slip of motor. When the slip compensation function is used, the rated rotating speed of motor should be set correctly (PA.03 and PA.17).

When the compensation gain is 0, the slip compensation will be ineffective.

P9.11 Energy efficient control selection	Setting range: 0, 1 [0]
--	-------------------------

0: Ineffective Energy Conservation

1: Effective Energy Conservation

Notes:

- ◆ The energy saving control parameters have been preset at the factory to the optimum values. It is not necessary to adjust them under normal operation. If your motor characteristic has great difference from those of standard induction motors, refer to the following description to adjust the parameters.

P9.12 Energy efficient gain coefficient	Setting range: 0.00~655.3 [Depend on model]
---	---

Notes:

- ◆ In the energy conservation control mode, the energy efficient gain factor is used to calculate the voltage of motor at its highest efficiency, which is used as the output voltage. The energy efficient factor P9.12 is preset according to the value of standard motor before Ex-factory. When the energy conservation gain factor increases, the output voltage will increase as well.

P9.13 Energy efficient voltage lower limit(50Hz)	Setting range: 0~120% [50%]
P9.14 Energy efficient voltage lower limit(5Hz)	Setting range: 0~25% [12%]

Notes:

- ◆ These parameters are used to set the lower limit of output voltage. If the voltage reference value calculated in the energy saving mode is smaller than the energy efficient voltage lower limit, this lower limit will be treated as the output voltage reference. To prevent the motor stalling at light loads, the energy efficient voltage lower limit must be set. Set voltage limits at 5Hz and 50Hz; the limit values other than 5Hz and 10Hz are obtained by linear interpolation. The setting value is percentage of motor rated voltage.

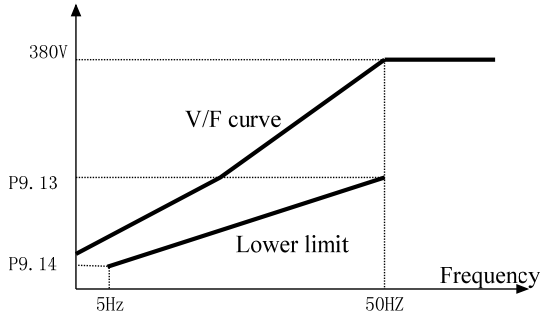

Fig. 5-9-5 Energy efficient voltage lower limit

- ◆ In the energy saving control mode, the optimum voltage supplied to the load is calculated according to load power. However, the set parameter may vary because of temperature variations or using various manufacturers' motors; therefore, the optimum voltage may not be supplied in some cases. Automatic fine-tuning control voltage maintains highly efficient operation.

P9.15 Average power time

Setting range: 1~200 * (25ms) [5]

Notes:

- ◆ Preset the time of average power calculating in energy-saving control mode. The setting range of P9.15 is 25ms * (1~200).

P9.16 AVR function

Setting range: 0~2 [2]

0: Inactive

1: Always Enabled

2: Inactive only during decelerating process

Notes:

- ◆ AVR means automatic output voltage regulation. When AVR function is invalid, the output voltage will fluctuate when the power supply voltage fluctuates. When it is valid, the output voltage would not fluctuate as the input voltage. The output voltage will keep constant within the inverter output capacity.

P9.17 Over modulation selection

Setting range: 0, 1 [0]

0: Disable

1: Enable

Notes:

- ◆ When the over modulation function is enabled, the inverter voltage output

capacity can be improved. However, if the output voltage is too high, the output current harmonics will increase.

P9.18 Droop control (load distribution)	Setting range: 0.00~10.00Hz [0.00Hz]
---	--------------------------------------

Notes:

- ◆ The function is applicable on the occasion where many inverters drive the same load. By setting the function, power can be distributed evenly when many inverters drive the same load.
- ◆ When the load current of an inverter is >50%, the inverter will reduce the output frequency appropriately automatically according to parameters set with the function to discharge certain load. Once the load current $\leq 50\%$, inverter will stop reducing the frequency. If the load current is larger than 50% all the time, the output frequency will be reduced to (the setting value of -P9.18).

Tips:

When the slip compensation and the droop control cannot be effective concurrently, the slip compensation takes higher priority.

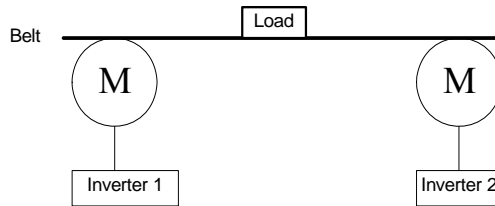

Fig. 5-9-6 Droop Control Motor Characteristic

P9.19 Output voltage offset source	Setting range: 0~5 [0]
------------------------------------	------------------------

- | | |
|---|------------------|
| 0: Digital setting | 1: Terminal AI1 |
| 2: AI2 (S2R4GB and S2R75GB do not have AI2) | 3: Reserve |
| 4: Pulse input | 5: communication |

P9.20 Output voltage offset	Setting range: 0.0%~100.0% [0.0%]
-----------------------------	-----------------------------------

Notes:

- ◆ In the V/F separation mode, the actual output voltage is the set output voltage bias. (100% corresponding to the maximum output voltage)

Tips:

The function is valid only in the V/F separate mode

P9.21 Oscillation suppression coefficient	Setting range: 0~100 [0]
---	--------------------------

Notes:

- ◆ In the case of no oscillation with the motor, please select the factor as 0. The factor can be increased appropriately only when the motor oscillates obviously and cannot operate normally. The larger the factor is, the stronger the suppression of motor oscillation. On the premise that motor oscillation is

suppressed effectively, the parameter should be as small as possible to avoid lowering in control performance.

5.11 Motor Parameters (Group PA)

PA.00 Motor selection	Setting range: 0, 1 [0]
-----------------------	-------------------------

0: Use motor 1

1: Use motor 2

Notes:

- ◆ You can set this function code to switch motor 1 and motor 2.

Tips:

After select the motor model, if the motor overload protection is realized by externally-connected sensor, you must set Pd.01 ~ Pd.04 correspondingly.

PA.01 Pole number of Motor 1	Setting range: 2~56 [4]
PA.02 Rated Power of Motor 1	Setting range: 0.4~999.9kW [Depend on model]
PA.03 Rated Speed of Motor 1	Setting range: 0~24000r/min [Depend on model]
PA.04 Rated Current of Motor 1	Setting range: 0.1~999.9A [Depend on model]

Notes:

- ◆ PA.01~PA.04 are used to set the parameters of the controlled motor 1. To ensure the control performance, please do set relevant values correctly according to parameters on the motor nameplate.
- ◆ The motor power should match that of the inverter. Generally, the motor power is allowed to be 2 steps lower than that of the inverter or one step higher; otherwise, the control performance would not be ensured.

PA.05 No-load Current I0 of Motor 1	Setting range: 0.1~999.9A [Depend on model]
PA.06 Stator Resistance R1 of Motor 1	Setting range: 0.001~65.000Ω [Depend on model]
PA.07 Leakage Inductance L1 of Motor 1	Setting range: 0.1~2000.0mH [Depend on model]
PA.08 Rotor Resistance R2 of Motor 1	Setting range: 0.001~65.000Ω [Depend on model]
PA.09 Mutual Inductive Impedance Lm of Motor 1	Setting range: 0.1~2000.0mH [Depend on model]
PA.10 Magnetic Saturation Coefficient 1 of Motor 1	Setting range: 0.0%~100.0% [Depend on model]
PA.11 Magnetic Saturation Coefficient 2 of Motor 1	Setting range: 0.0%~100.0% [Depend on model]
PA.12 Magnetic Saturation Coefficient3 of Motor 1	Setting range: 0.0%~100.0% [Depend on model]

Chapter 5 Detailed Function Introductions

PA.13 Magnetic Saturation Coefficient 4 of Motor 1	Setting range: 0.0%~100.0% [Depend on model]
PA.14 Magnetic Saturation Coefficient 5 of Motor 1	Setting range: 0.0%~100.0% [Depend on model]

Notes:

- ◆ If the motor parameters are unknown, please refer to the PA.29 motor parameters tuning instruction. If they are known, please put them into PA.05~PA.09 correspondingly.
- ◆ The motor magnetic saturation coefficients will be tuned automatically in motor auto tune function and doesn't have to be set by users.

PA.15 Motor 2 pole number	Setting range: 2~56 [4]
PA.16 Motor 2 rated power	Setting range: 0.4~999.9kW [Depend on model]
PA.17 Motor 2 rated speed	Setting range: 0~24000r/min [Depend on model]
PA.18 Motor 2 rated current	Setting range: 0.1~999.9A [Depend on model]
PA.19 Motor 2 no-load current I0	Setting range: 0.1~999.9A [Depend on model]
PA.20 Motor 2 stator resistance R1	Setting range: 0.001~65.000Ω [Depend on model]
PA.21 Motor 2 leakage inductance L1	Setting range: 0.1~2000.0mH [Depend on model]
PA.22 Motor 2 rotor resistance R2	Setting range: 0.001~65.000Ω [Depend on model]
PA.23 Motor 2 mutual inductive reactance Lm	Setting range: 0.1~2000.0mH [Depend on model]
PA.24 Motor 2 magnetic saturation coefficient 1	Setting range: 0.0%~100.0% [Depend on model]
PA.25 Motor 2 magnetic saturation coefficient 2	Setting range: 0.0%~100.0% [Depend on model]
PA.26 Motor 2 magnetic saturation coefficient 3	Setting range: 0.0%~100.0% [Depend on model]
PA.27 Motor 2 magnetic saturation coefficient 4	Setting range: 0.0%~100.0% [Depend on model]
PA.28 Motor 2 magnetic saturation coefficient 5	Setting range: 0.0%~100.0% [Depend on model]

Notes:

- ◆ The detailed parameters settings of motor 2 are the same as motor 1. The settings are valid after the PA.00 is set to 2.

PA.29 Motor parameter tuning	Setting range: 0~2 [0]
------------------------------	------------------------

- 0: No operation
- 1: Static parameter tuning
- 2: Dynamic parameter tuning

Notes:

- ◆ S2R4GB and S2R75GB is reserved.
- ◆ 0: No operation
- ◆ 1: Static parameter tuning; it is applicable on occasions where a motor and load cannot be disconnected easily and rotary tuning is not allowed. When the function code is set and command to RUN, the frequency converter will tune parameters PA.06~PA.08 / PA.20~PA.22 automatically.
PA.05, PA.09 / PA.19 and PA.23 should be set manually according to the standard motor parameters.
- ◆ 2: Dynamic parameter tuning: to ensure the dynamic control performance of frequency converter, please select the rotary parameter tuning. At setting, the motor should be disconnected from the load (no load). When the function code is set and command to RUN, the motor parameters will be automatically tuned.

 Tips:

1. Before the self-tuning, please enter the correct nameplate parameter of the controlled motor (PA.01 ~ PA.04 PA.15 ~ PA.18).
2. When dynamic tuning, you should let the motor off from the load. It is banned to do motor tuning with the load.
3. Before self-tuning, please confirm that the motor is in stopping state. Otherwise, it cannot be carried out normally.
4. After the auto-tuning is completed (including abnormal end), PA.29 is automatically set to 0.
5. During the process of parameter tuning, the operation panel will display “- At-”. If the tuning is unsuccessful, the operation panel will display “AtE”.

Notes:

At the time of static tuning, the calculation method of motor's no-load current and mutual inductance are showed in the following formulae. Among them, L is the leakage inductance, I_0 is the no-load current, L_m is the mutual inductance, η is the efficiency, I is the rating current, U is the rating voltage, and f is the fundamental frequency of motor.

$$\text{No load current: } I_0 = I \cdot \sqrt{1 - \eta^2}$$

$$\text{Mutual inductance calculations: } L_m = \frac{U}{2\sqrt{3}\pi f \cdot I_0} - L$$

The specific meanings of the above motor parameters are showed in Fig. 5-10-1.

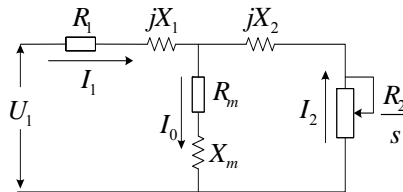

Fig. 5-10-1 Stable-state Equivalent Circuit Diagram of the Asynchronous Motor

In Fig. 5-10-1, R_1 , X_1 , R_2 , X_2 , X_m and I_0 respectively represent the stator resistance, stator leakage inductive impedance, rotor resistance, rotor leakage inductive impedance, mutual inductive impedance and no-load current.

5.12 MODBUS Communication (Group Pb)

The series inverters can perform the serial communication via the MODBUS communication protocol with the programmable logic controller (PLC). The MODBUS network consists of a master (PLC) and 1~31 slavers (inverters). The message transmission between the PLC and inverters is always started by the PLC, and the inverter, which received the message from PLC, executes the function and responses to PLC.

- ◆ Communication Specification
Interface: RS-485
Synchronization Manner: half-duplex asynchronous
- ◆ Transmission Parameters
Baud rate: Selectable from 1200, 2400, 4800, 9600, 19200, 38400 bps (parameter Pb.00)
RTU mode: data length fixed at 8 bits, stop bit fixed at 1 bit.
ASCII mode: 7 data bits and 8 data bits is optional. There is 1 stop bit when parity is active and there are 2 stop bits when parity is inactive (Pb.02).
Parity: even parity/no parity/odd parity selectable (parameter Pb.02)
Protocol: In accordance with MODBUS
Maximum number of inverters to be connected: 31 units
- ◆ Data sent/received through communication: include the operation command, frequency giving, fault content, invert state and setting & reading of function parameters. The monitoring and the reading & writing function parameters is active at starting up by default;

Pb.00 Baud rate selection	Setting range: 0~5 [3]
0: 1200 bps	1: 2400 bps
2: 4800 bps	3: 9600 bps
4: 19200 bps	5: 38400 bps

Pb.01 Inverter address	Setting Range: 0~31 [1]
-------------------------------	--------------------------------

Notes:

- ◆ The address of the inverter set cannot be the same with the addresses of other controlled devices connected to the same transmission line.

Pb.02 Communication data format	Setting Range: 0~8 [0]
0: 1-8-1-E, RTU	1: 1-8-1-O, RTU
2: 1-8-1-N, RTU	3: 1-7-1-E, ASCII
4: 1-7-1-O, ASCII	5: 1-7-2-N, ASCII
6: 1-8-1-E, ASCII	7: 1-8-1-O, ASCII
8: 1-8-2-N, ASCII	3~8: Reserve

Pb.03 Communication timeout detection time	Setting Range: 0~100.0s [0.0s]
---	---------------------------------------

Notes:

- ◆ 0: there is no timeout check
- ◆ Non-0: there is the timeout check. The system will check the communication state at the interval of the Pb.03 setting value. If there is no normal data received or sent, the system will report the external communication fault (EF0) and stop the machine; the fault should be cleared manually

Tips:

If only abnormal data are received during the timeout check, they will not be used as the base for being in communication and fault will be reported;

Pb.04 Response delay time	Setting range: 0~500ms [5ms]
---------------------------	------------------------------

Notes:

- ◆ It refers to the time from inverter receiving the host PC command to returning response to it.

Pb.06 EEPROM save selection	Setting range: 0, 1 [0]
-----------------------------	-------------------------

0: Not directly save to EEPROM

1: Directly save to EEPROM

Notes:

- ◆ This function code is used to select whether to save the MODBUS data to EEPROM. If pb.06 is set as 1, parameters that are modified by MODBUS communication will be saved to EEPROM directly. However, if Pb.06 is set as 0, the modified parameters will not be saved to EEPROM, but stored in RAM and they will be lost when power is off. The other method to save the data to EEPROM is that write the MODBUS address corresponding to the modified parameter to 0x00FF, then the data will be saved to EEPROM which acts as the “ENTER “key to save the data.

 Write or erase EEPROM frequently will reduce the life of EEPROM. Some parameters don't need to be saved in communication mode, while revising the RAM value is enough. In this case, set Pb.06=0.

Pb.07 CCF6 fault handling	Setting range: 0, 1 [0]
---------------------------	-------------------------

0: Resume without reporting failure

1: Report failure and stop

Notes:

- ◆ This function code is used to decide whether to generate communication fault or not. When the value is 1, if communication fault occurs, the keypad will display CCF6 and the inverter stop according to the set stop mode; when the value is 0, it doesn't report the fault and the inverter will keep on running.

Pb.08 response control	Setting range: 0, 1 [0]
------------------------	-------------------------

0: normal response

1: no response when writing instruction

Notes:

- ◆ If this Function code is set to 1, there is no response when the inverter received writing instruction. And there is response when the inverter received other instruction.

5.13 Display Control (Group PC)

PC.01 Output frequency (Hz) (Before compensation)	Setting range: 0, 1 [1]
PC.02 Output frequency (Hz) (Actual)	Setting range: 0, 1 [0]

0: Not displayed

1: Displayed

Notes:

- ◆ When PC.01 is set as 1, the output frequency before compensation will be displayed in the monitoring state, and the indicator light will indicate the unit Hz; if it is set as 0, the output frequency before compensation and the unit will not be displayed.
- ◆ When PC.02 is set as 1, the actual output frequency will be displayed in the monitoring state, and the unit is Hz; if it is set as 0, the object will not be displayed.

PC.03 Output current (A)	Setting range: 0, 1 [1]
--------------------------	-------------------------

0: Not displayed

1: Displayed

Notes:

- ◆ When PC.03 is set as 1, the output current will be displayed in the monitoring state and the unit is A. If it is set as 0, the object will not be displayed.

PC.04 Setting frequency (Hz, Flicker)	Setting Range: 0, 1 [1]
---------------------------------------	-------------------------

0: Not displayed

1: Displayed

Notes:

- ◆ PC.04 can be set as 1. Switch to this monitored object by pressing the “>>” key. When the target is selected, the unit is indicated as Hz and is flickering. If P0.03 is set as 1, frequency can be set via the knob on the keypad. If P0.17 is set as 0, the adjustment rate can be adjusted from 0.01Hz to 0.1Hz, even to the maximum of 1Hz to realize the rapid increase or decrease of frequency by turning the knob continuously. Please refer to P0.17 for details.

PC.05 Operating speed (r/min)	Setting range: 0, 1 [1]
-------------------------------	-------------------------

PC.06 Setting speed (r/min, Flicker)	Setting range: 0, 1 [0]
--------------------------------------	-------------------------

0: Not displayed

1: Displayed

Notes:

- ◆ When PC.05 is set as 1, the operating rotating speed will be displayed in the monitoring state and the unit is r/min. If it is set as 0, the object will not be displayed.
- ◆ When PC.06 is set as 1, the set rotating speed will be displayed in the monitoring state and the unit is r/min and is flickering.
- ◆ If PC.06=1, when the user switches to PC.05 or PC.06 by pressing >>: if it is the ordinary operation and P0.03 is set as 1 (keypad digital setting), the rotating speed can be adjusted on line by turning the keypad knob and the corresponding frequency value will be saved to P0.02 after pressing ENTER; if it is the PID operation, and P7.00 is set as 0, P7.03 is set as 0 (PG or single-phase

speed-measuring input), the speed PID giving can be adjusted on line and be saved in P7.08 after pressing ENTER; if P7.03 is not 0 (PG or the single-phase speed-measuring input), it cannot be adjusted. PC.06 will be displayed during the on-line adjustment. After adjustment is over, the object before adjustment will be displayed.

PC.07 Operating linear speed (m/s)	Setting range: 0, 1 [0]
PC.08 Setting linear speed (m/s, Flicker)	Setting range: 0, 1 [0]

0: Not displayed

1: Displayed

Notes:

- ◆ When PC.07 is set as 1, the operation linear speed will be displayed in the monitoring state and the unit is m/s (the indicator light of m/s is on). If it is set as 0, the object will not be displayed.
- ◆ When PC.08 is set as 1, the set linear speed will be displayed in the monitoring state and the unit is m/s (the indicator light of m/s is on and flickering) (the object cannot be adjusted on line).

PC.09 Output power(kW)	Setting range: 0, 1 [0]
------------------------	-------------------------

0: Not displayed

1: Displayed

Notes:

- ◆ When PC.09 is set as 1, the output power (no unit is displayed) will be displayed in the monitoring state. If it is set as 0, the object will not be displayed.

PC.10 Output torque (%)	Setting range: 0, 1 [0]
-------------------------	-------------------------

0: Not displayed

1: Displayed

Notes:

- ◆ If PC.10 is set to 1, output torque will be displayed with unit “%” in monitoring state. If PC.10 is set to 0, output torque will not be displayed.

PC.11 Output voltage (V)	Setting range: 0, 1 [1]
--------------------------	-------------------------

PC.12 Bus voltage (V)	Setting range: 0, 1 [0]
-----------------------	-------------------------

0: Not displayed

1: Displayed

Notes:

- ◆ If PC.11 is set to 1, output voltage will be displayed in monitoring state, and the unit indicator “V” will be lit up. If it is set to 0, output voltage will not be displayed.
- ◆ If PC.12 is set to 1, bus voltage will be displayed in monitoring state, and the unit indicator “V” will be lit up. If it is set to 0, bus voltage will not be displayed.

PC.13 AI1 (V)	Setting range: 0, 1 [0]
---------------	-------------------------

PC.14 AI2(V) (S2R4GB and S2R75GB do not have AI2)	Setting range: 0, 1[0]
---	------------------------

0: Not displayed

1: Displayed

Notes:

- ◆ If PC.13 is set to 1, analog input voltage AI1 will be displayed in monitoring state, and the unit indicator “V” will be lit up. If it is set to 0, analog input voltage AI1 will not be displayed.
- ◆ If PC.14 is set to 1, analog input voltage AI2 will be displayed in monitoring state, and the unit indicator “V” will be lit up. If it is set to 0, analog input voltage AI2 will not be displayed.

PC.16 Analog PID feedback (%)	Setting range: 0, 1 [0]
PC.17 Analog PID feeding (% , Flicker)	Setting range: 0, 1 [0]
0: Not displayed	1: Displayed

Notes:

- ◆ Analog PID setting/feedback: the physical quantity percentage corresponding to the Analog value * analog closed loop measurement range
- ◆ When PC.16 is set as 1, the analog PID feedback will be displayed in the monitoring state without the indication unit. If it is set as 0, the object will not be displayed.
- ◆ When PC.17 is set as 1, the analog PID setting can be displayed in the monitoring state. When P7.00 is set as 0 and P7.08 is not set as 0, the analog PID setting can be adjusted on line when switching to PC.16 or PC.17 by pressing the shift key “>>” and the newly set value will be saved in P7.06 after pressing ENTER. During the on-line adjustment, PC.17 will be displayed. The object before adjustment will be displayed after adjustment is over.

PC.18 External count value (No unit)	Setting range: 0, 1 [0]
0: Not displayed	1: Displayed

Notes:

- ◆ If PC.18 is set to 1, external count value will be displayed in monitoring state, and all unit indicators will be off. If it is set to 0, external count value will not be displayed.

PC.19 Terminal status (no unit)	Setting range: 0, 1 [0]
0: Not displayed	1: Displayed

Notes:

- ◆ When PC.19 is set as 1, the terminal status will be displayed. If it is set as 0, the object will not be displayed.
- ◆ The terminal status information includes the status of the multifunctional terminals X1~X6, two-way open collector output terminals D0, and output relay 1. The status of the function terminals is indicated by ON/OFF of the specified segment of an LED digital tube. If the digital tube segment is on, it indicates that the status of the corresponding terminal is in the effective status; if it is off, it indicates that the status is the ineffective status. There are four constantly-on segments with the digital tube to facilitate observation. It is showed as in Fig. 5-12-1:

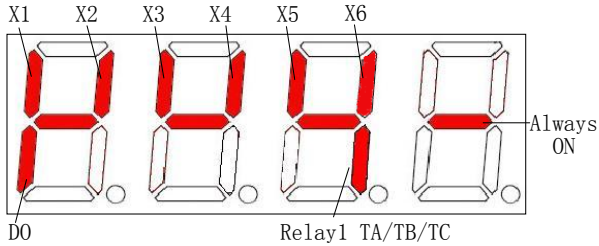

Fig. 5-12-1 Terminal Status Indication

PC.21 Power on display selection	Setting range: 1~20 [1]
----------------------------------	-------------------------

Notes:

- ◆ PC.21 startup display selection: the function code is used to set the prior displayed parameter at startup. The setting values 1~20 correspond to PC.01~PC.20 respectively. When the chosen prior displayed parameter's display setup is 0 (not displayed), the system will search backwards from the current parameter until it goes to the parameter whose display setting is not 0 and display its accordant value. The searching will follow ascending order and return to PC.01 when it reaches PC.20.
- ◆ The displaying priority set here is only limited to the parameters of PC.01~PC.20 and are only valid at startup. When there is a fault, warning or communication CALL displayed, the parameters will be displayed according to the original priority order and the current priority display will not act.

PC.22 Speed display coefficient	Setting range: 0.1~999.9% [100.0%]
---------------------------------	------------------------------------

Notes:

- ◆ PC.22 (Speed display coefficient) is used to correct the bias of displayed rotating speed and it has no influence on actual speed.
- ◆ Mechanical Rotating Speed = Detected Actual Rotating Speed * PC.22 (PG)
- ◆ Mechanical Rotating Speed = $120 * \text{Running Frequency} / \text{Motor Pole Number} * \text{PC.22 (Non-PG)}$
- ◆ Setting Rotating Speed = PID Reference Rotating Speed * PC.22 (PG)
- ◆ Setting Rotating Speed = $120 * \text{Setting Frequency} / \text{Motor Pole Number} * \text{PC.22 (Non-PG)}$

PC.23 Linear speed coefficient	Setting Range: 0.1~999.9% [100.0%]
--------------------------------	------------------------------------

Notes:

- ◆ PC.23 linear speed coefficient: It is used to revise the linear speed display error and has not effect on the actual rotating speed.
- ◆ Linear speed = Running frequency * PC.23 (non PG)
- ◆ Linear speed = mechanical rotate speed * PC.23 (PG)
- ◆ Setting linear speed = setting frequency * PC.23 (non PG)
- ◆ Setting linear speed = setting speed * PC.23 (PG)

Tips:

Display Scope:

Linear speed and Setting: 0.000~65.53m/s	Output power	0~999.9kW
Output torque 0~300.0%	Output voltage	0~999V
Bus voltage 0~1000V	AI1/AI2	0.00~11.00V
External counting value 0~65530		

5.14 Protection and Fault Parameters (Group Pd)

Pd.00 Motor overload protection mode selection	Setting range: 0~3 [1]
--	------------------------

- 0: No protection
- 1: Common motor (with low speed compensation)
- 2: Variable frequency motor (without low speed compensation)
- 3: Sensor Protection (Immediate protection once over threshold)

Notes:

- ◆ No Action
When 0 is selected, the inverter has no overload protection of the loaded motor, so it should be selected and used prudently;
- ◆ Common Motor (Compensation at the Low Speed)
As the fan of common motor is installed on the rotor shaft of motor and the fan rotates slowly in the case of low speed, the heat radiation will get poor and the corresponding electronic thermal protection value will be adjusted appropriately, i.e. the overload protection threshold value of motor whose operation frequency is lower than 30Hz is reduced.
- ◆ Variable-frequency Motor (No Compensation at the Low Speed)
As the fan of the special variable-frequency motor is not installed on the rotor shaft, the fan heat radiation will not be affected by the rotating speed and the protection value in the case of low-speed operation should not be adjusted.
- ◆ Sensor Protection (Immediate protection once over threshold)
The protection function of the external thermal relay of motor is realized.
The protection threshold values of motor 1 and motor 2 are set through Pd.01 and Pd.03;
The sensor passage is set through Pd.02 and Pd.04.

Pd.01 Motor 1 protection threshold	Setting range: 0.0~10.0V [10.0V]
Pd.02 Motor 1 protection sensor input channel	Setting range: 0~4[0]
Pd.03 Motor 2 protection threshold	Setting range: 0.0~10.0V [10.0V]
Pd.04 Motor 2 protection sensor input channel	Setting range: 0~4[0]

- 0: Terminal AI1
- 1: AI2 (S2R4GB and S2R75GB do not have AI2)
- 2: Reserve
- 3: Pulse input
- 4: Communication setting

Pd.05 Electronic thermal relay protection value	Setting range: 20~110% [100%]
---	-------------------------------

Notes:

- ◆ In order to apply effective overload protection to different kinds of motors, the max output current of the inverter should be adjusted as shown in Fig. 5-13-1.

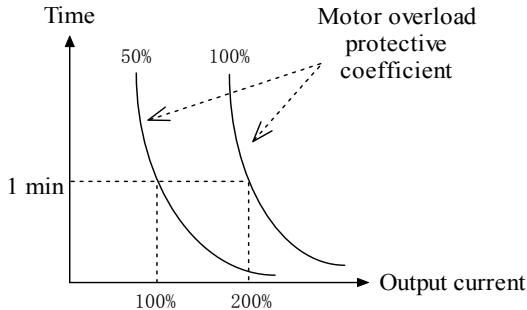

Fig. 5-13-1 Motor overload protection curve

Adjustment can be determined according to the following formula:

$$\text{Pd.05} = \frac{\text{Allowed Max. Load}}{\text{Rated Output Current of Inverter}} \times 100\%$$

Here in, “Allowed Max. Load Current” is the rated current of motor generally.

For the motor with the better heat resistance, the value can be increased by a little (e.g. 10%); for the motor with the weaker heat resistance, the value can be decreased by a little.

Tips:

When the rated current of motor doesn't match with that of inverter, the motor can be protected effectively by setting the value of Pd.05. When protection acts, PWM will be blocked and OL1 fault will be reported.

Pd.06 Overload pre-alarm detection level	Setting range: 20.0~200.0% [160.0%]
Pd.07 Overload pre-alarm detection time	Setting range: 0.0~60.0s [60.0s]

Notes:

- ◆ The overload pre-alarm detection level (Pd.06) defines the current threshold of overload pre-alarm action. Its set value corresponds to the percentage of the rated current of inverter.
- ◆ The overload pre-alarm detection time (Pd.07) defines that the overload pre-alarm signal OLP2 will be given out after the output current of inverter keeps larger than the overload detection level (Pd.06) for certain time continuously.
- ◆ Overload pre-alarm state effective means that the working current of inverter is over the overload detection level and its duration time is over the overload detection time.

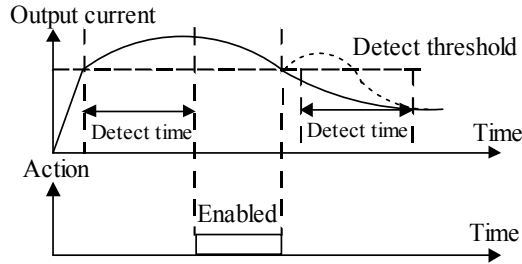

Fig. 5-13-2 Overload pre-alarm function

Tips:

1. For setting of the overload pre-alarm detection level\ detection time, it should be generally ensured that the pre-alarm occurs earlier than the overload protection action of inverter.
2. Within the overload pre-alarm detection time, if the working current is less than the overload pre-alarm detection level, the overload pre-alarm detection time inside the inverter will be reset.

Pd.08 Current amplitude limit	Setting range: 0~3 [1]
0: Invalid	1: Valid during acceleration and deceleration, invalid during constant speed operation
2: Valid all the time	3: Decrease operating speed during over current
Pd.09 Current amplitude limiting level	Setting range: G Type: 30~180%[160%] P Type: 60~140%[120%]

Notes:

- ◆ When the inverter is running at Acc/Dec or constant speed, there may be a sharp increase in the current, because of the mismatch of Acc/Dec time and motor inertia, or the mutation of load torque. In order to control the output current, when Pd.08 is set to 1 and 2 or 3, the inverter's output frequency may be adjusted automatically.
- ◆ When it is set as 1 or 2, if the output current value reaches the current limit action level Pd.09 during Acc/Dec, the output frequency of inverter will not change until the current is restored to the normal and finally controls that the output current will not be higher than the Pd.09 value.
- ◆ In the case of stable-speed operation, if Pd.08 is selected as 2, when the current value reaches the current limit action level Pd.09, the inverter will reduce the output frequency according to the deceleration time 4 and restore to the original working state after the current is reduced. If Pd.08 is selected as 1, the output frequency of inverter will not change.
- ◆ If Pd.08 is selected as 3, when the current value reaches the current limit action level Pd.09 and last for the time set by Pd.20, then the inverter will reduce the output frequency according to the deceleration time 4 and restore to the original working state after the current is reduced.

- ◆ During the process of deceleration, if the inverter is at the state of current limit for over 1min, the OL2 overload alarm of inverter will be given out and the motor will coast to stop; or by pressing the button of STOP/RESET twice (at the interval not less than 2s), the OL2 overload alarm of inverter will be given out and the motor will coast to stop.

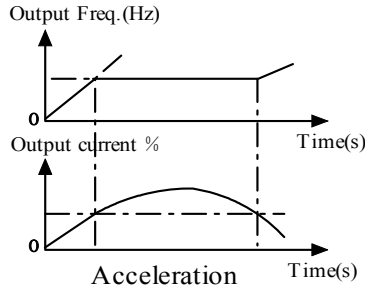

Fig. 5-13-3 Acceleration

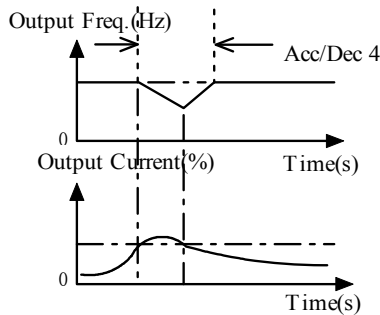

Fig. 5-13-4 constant speed Operation

Pd.10 Over-voltage stall selection	Setting range: 0, 1 [1]
0: Prohibited (The proposed option, when braking resistor is mounted)	
1: Allowed	
Pd.11 Over-voltage stall point	Setting Range: 110.0~150.0% bus voltage [220V: 120%; 380: 140%]

Notes:

- ◆ The bus voltage is approximately equal to (the input voltage \times 1.414). For the inverter with the input voltage of 220V, the default value of Pd.11 is 120% (about 373V); for the inverter with the input voltage of 380V, the default value of Pd.11 is 140% (about 752V).
- ◆ The dynamic braking action voltage point is also related to the parameter. For the inverter with the input voltage of 380V, the dynamic braking action voltage is 52V lower than the overvoltage stalling point (i.e. the default action point is 700V).

For the inverter with the input voltage of 220V, it is 23V lower (i.e. the default action point is 350V).

- ◆ During the decelerating operation of inverter, the actual decrease rate of the motor rotating speed may be lower than that of the inverter output frequency. In this case, the motor is at the state of power generation and will feed energy to the inverter, which will cause the DC bus voltage of inverter to rise. If corresponding measures are not taken, the overvoltage fault will occur.
- ◆ If Pd.10=1 is effective, when the DC bus voltage rises to a certain value (\geq Pd.11) during deceleration, deceleration will be paused and the inverter will keep the output frequency unchanged. Deceleration will not be started again until the DC bus voltage is reduced.
- ◆ When the inverter is at the overvoltage stalling state for over 1min continuously, the “Ou” overvoltage alarm will be reported and the motor will coast to stop; or by pressing the button STOP/RESET and then pressing the button STOP/RESET twice (at the interval not less than 2s), the inverter will report the overvoltage and the motor will coast to stop

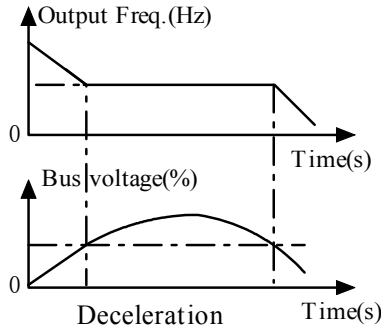

Fig. 5-13-5 Deceleration

Pd.12 Input phase loss detection benchmark	Setting range: 1~100% [100%]
Pd.13 Input phase loss detection time	Setting range: 2~255s [10s]

Notes:

- ◆ With this function, the input phase loss or the serious imbalance of the input three phases can be detected to protect the inverter. If the input phase loss protection is too sensitive, the detection benchmark and the detection time can be increased appropriately. If it is not so sensitive, the detection benchmark and the detection time can be reduced.

Pd.14 Output phase loss detection benchmark (reserve in S2R4GB and S2R75GB)	Setting Range: 0~100% [1%]
Pd.15 Output phase loss detection time (reserve in S2R4GB and S2R75GB)	Setting Range: 0.0~20.0s [2.0s]

Notes:

- ◆ With this function, the output phase loss or the serious imbalance of the output three phases can be detected to protect the inverter and motor. If the output phase loss protection is too sensitive, the detection benchmark and the detection time can be increased appropriately. If it is not so sensitive, the detection benchmark and the detection time can be reduced.

Pd.17 AE1, AE2 (S2R4GB and S2R75GB do not have AE2) alarm selection	Setting range: 0, 1 [0]
0: Do not display warning	1: Display warning

Notes:

- ◆ With this function, it can be set whether the alarm will be displayed in the case of abnormal analog signal; when it is set as 1, if the analog signal 1 is abnormal, the alarm AE1/AE2 will be displayed; when it is set as 0, the alarm will not be displayed.

Pd.18 Automatic reset times	Setting Range: 0~10 [0]
Pd.19 Reset interval time	Setting Range: 2.0~20.0s [5.0s]
Pd.20 Confirm time before over current deceleration	Setting Range: 0~200ms [50ms]

Notes:

- ◆ Only three faults including OC, Ou and GF can be reset automatically.
- ◆ The three faults in operation can be reset automatically according to the set times (Pd.18) and interval time (Pd.19). During the resetting interval, output is blocked and the inverter operates with zero frequency. The inverter will operate with the startup manner after automatic resetting is finished. When Pd.18 is set as 0, it means that there is not the function of automatic resetting, and protection should be done immediately.



Tips:

Be careful in using auto-reset function, otherwise human injury or material loss may occur.

SC fault need 10 seconds waiting time for manual reset.

Pd.21 Operation protection when power on	Setting range: 0, 1 [0]
0: No protection	1: Protection
Pd.22 Operation protection after control command set channel switching	Setting range: 0, 1 [0]
0: Continue to run	1: Stop, restart after receive new run command

Notes:

- ◆ When Pd.21 is set to 1, the power-on operation protection is invalid. Namely the inverter will get power-on operation protection if it is powered up when the RUN command is still effective. The inverter will not work until receive new operation command.
- ◆ When Pd.22 is set to 1, the inverter in stopping state will not immediately run after the command channel switching until receive a new operation command. If

the inverter gets command channel switching during operation, it will decelerate to stop. And it will restart once it gets a new operation command.

Pd.33 Software Current-limiting Point (reserve in S2R4GB and S2R75GB)	Setting Range: 100.0%~300.0% [Depend on model]
Pd.34 Hardware Current-limiting Enabled (reserve in S2R4GB and S2R75GB)	Setting Range: 0, 1 [1]
0: Prohibited 1: Allowed	
Pd.35 Input phase loss detection by hardware (3030G/3037P and below power do not have this function)	Setting Range: 0, 1[1]
0: Prohibited 1: Allowed	

Notes:

- ◆ The software current-limiting point 100.0% corresponds to the rated current of inverter.
- ◆ The hardware current-limiting point is fixed as 230.0% of the rated current of inverter. The specific value is related to the inverter power rating.
- ◆ Compared with the software current-limiting function, hardware current-limiting responds more quickly. Thus, it is suggested that hardware current-limiting function not be cancelled.

5.15 Running History Record (Group PE)

PE.00 Displayed fault selection	Setting range: 0~30[1]
PE.01 Type of fault	Setting range: Table 5-14-1 [NULL]
PE.02 Output frequency at fault	Setting range: 0~Frequency upper limit [0.00Hz]
PE.03 Setting frequency at fault	Setting range: 0~Frequency upper limit [0.00Hz]
PE.04 Output current at fault	Setting range: 0~2 times of (rated current) [0.0A]
PE.05 Bus voltage at fault	Setting range: 0~1000V [0V]
PE.06 Running status at fault	Setting range: 0~3 [StP]
0: StP Stop 1: Acc Accelerate	
2: dEc Decelerate 3: con Constant	
PE.07 Total power-on time at fault	Setting range: 0~65530h [0]
PE.08 IGBT temperature at fault	Setting range: 0.0~200.0°C [0.0°C]

Notes:

- ◆ If the inverter fails during operation, the PWM output will be blocked immediately to enter the fault protection state and the fault indicator light TRIP will be flickering. The operating conditions will be recorded at the same time when fault occurs (including output frequency, setting frequency, output current, bus voltage, operating conditions, accumulated switched-on time before the

failure and so on). At most the latest 30 groups of fault information can be recorded. The specific fault information group can be selected to display in PE.01-PE.08 by setting PE.00, 0 denotes not displaying the fault information and 1 denotes displaying the latest fault information (Null if there is no fault), the larger the number means the earlier fault information; the greatest value of PE.00 cannot exceed the recorded fault information groups. Instruction of fault types is showed in Table 5-14-1:

Table 5-14-1 Instruction of Fault Types

Fault code	Description	Fault code	Fault categories
NULL	No fault	Uu1	Bus Under-voltage
Uu2	Control circuit Under-voltage	Uu3	Charging circuit fault
OC1	Over current in Acc process	OC2	Over current in Dec process
OC3	Over current in constant speed Operation	Ou1	Over Voltage in Acc process
Ou2	Over Voltage in Dec process	Ou3	Over voltage in constant speed operation
GF	Ground Fault	OH1	Heat-sink Overheat
OL1	Motor Overload	OL2	Inverter Overload
SC	Load Short-Circuit	EFO	External Fault of serial communication
EF1	External Fault of terminal	SP1	Input phase loss or imbalance
SPO	Output phase loss or imbalance	CCF1	Control Circuit Fault 1: Transmission between the inverter and keypad cannot be established 5 seconds after supplying power.
CCF2	Control circuit fault 2: Transmission between the inverter and keypad is established once after supplying power, but later transmission fault continues for more than 2 seconds.	CCF3	EEPROM Fault
CCF4	AD Conversion Fault	CCF5	RAM Fault
CCF6	CPU disturbance	PCE	Parameters copy Error
HE	Hall current detection fault	DE	Detecting Error
CUE	Feed off fault	OH3	Rectifier bridge overheat

PE.10 Total operation time(h)	Setting range: 0~65530h [0]
PE.11 Total power-on time(h)	Setting range: 0~65530h [0]
PE.12 Total electricity consumption (MWh)	Setting range: 0~9999MWh [0]
PE.13 Total electricity consumption (KWh)	Setting range: 0~999K Wh [0]

Notes:

- ◆ Total operation Time (h): total time of the inverter in the operation state.
- ◆ Total power-on time (h): accumulated time of the inverter in the power-on state.
- ◆ Total electricity consumption (MWh): the high digit of accumulated power consumed by the inverter
- ◆ Total electricity consumption (KWh): the low digit of accumulated power consumed by the inverter

PE.14 IGBT temperature	Setting range: 0.0~200.0°C [0.0°C]
------------------------	------------------------------------

Notes:

- ◆ This parameter is used to display current temperature of IGBT of the inverter.

PE.15 Rectifier bridge temperature	Setting range: 0.0~200.0°C [0.0°C]
------------------------------------	------------------------------------

Notes:

- ◆ This parameter is used to display current temperature of Rectifier bridge of the inverter.

5.16 Protection of Parameters (Group PF)

PF.00 User password	Setting range: 0~9999 [0]
---------------------	---------------------------

Notes:

- ◆ User password setting: The initial value of user password is 0, which means the password protection function is invalid. At this state, user can access all parameters and parameters content of Group PF.
- ◆ User Password Unlocking: After the user password is set and becomes effective, the password should be input for unlocking to enter Group PF again. Otherwise, all other parameters in Group PF cannot be accessed.
- ◆ Changing the user password: If password protection function is effective, right password must be input first to unlock. After unlocking, select PF.00, re-change this parameter value, and press “ENTER” to save the value. Now, the password changing is completed. Before changing the user password, remember to set PF.01 to 0, so that all parameters are allowed to be changed.

Tips:

The password will become effective when you press “PRG/ESC” to exit from Group PF if you set user password.

Please remember the password; otherwise, you will have no access to all parameters of Group PF.

If you forget user password, please contact with manufacturer.

Example: Set the password to 1234, then exit from Group PF and unlock the user password. The process is shown in Fig. 5-15-1 and Fig. 5-15-2.

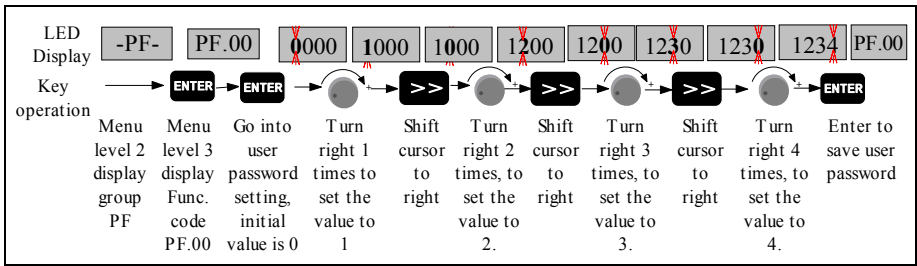

Fig. 5-15-1 Flow chart of user password setting

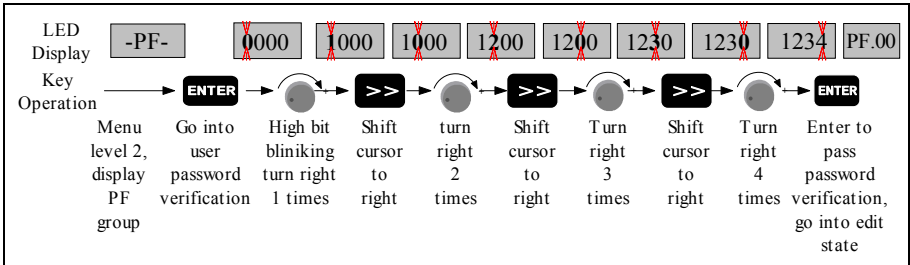

Fig. 5-15-2 Flow chart of user password unlocking

PF. 01 Parameter write protection	Setting range: 0~2 [0]
-----------------------------------	------------------------

0: All parameters are allowed to be rewritten

1: Except for the frequency digital setting (P0.02) and this function code(PF.01), other function codes are prohibited to be rewritten

2: Except for this function code, all others are prohibited to be rewritten

Notes:

- ◆ PF.01 is set to 0: All parameters are allowed to be changed. But only the parameters, which are marked “○” in function table, can be changed no matter when the inverter is running or stop. The parameters, which are marked “×”, can be changed only when the inverter is in stop state. Other parameters cannot be changed. About the changeability of parameters, refer to Chapter 4 for details. In addition, you can examine the parameters display on keypad. If any digit of the parameter is flashing, the parameter is allowed to change. If none digit of the parameter is flashing, it cannot be changed.
- ◆ PF.01 set as 1: except for the frequency digital setting (P0.02) and this function code, other function codes are prohibited to be changed.
- ◆ PF.01 set as 2: except for this function code, all others are prohibited to be changed.

Tips:

In the state of startup parameter monitoring, when PF.01 is set as 0, all parameters are allowed to be revised, and the set frequency, speed PID giving and analog PID digital giving can be adjusted and saved on line. When PF.01 is set as 1, only the set frequency can be adjusted and saved. When PF.01 is set as 2, all on-line adjustments are invalid.

PF.02 Parameter initialization	Setting range: 0~3 [0]
0: No operation	1: Clear fault record
2: Restore factory settings (except the record/password/motor parameters)	3: Restore factory settings (except the record/password)

Notes:

- ◆ When PF.02 is set as 0, there is no operation.
- ◆ When PF.02 is set as 1, all fault records of PE.00~PE.08 in Group PE will be cleared to facilitate debugging and fault analysis by the user.
- ◆ When PF.02 is set as 2, except for the operation history records, user password setting and motor parameters, all other parameters will be restored to default setting.
- ◆ When PF.02 is set as 3, except for the operation history records and user password setting, all other parameters will be restored to default setting.

Tips:

If user forget the setting value of parameters, and do not want to set them one by one, setting PF.02 to 2 can be used to rapidly restore to defaults, in favor of parameters resetting.

After the historical fault records are cleared or the factory values are reset, PF.02 will be restored to 0 automatically, which means that the corresponding operation has been finished.

PF.03 Parameters copy	Setting range: 0~3[0]
0: No action	1: Download parameters
2: Upload parameters	3: Download parameters except motor's

Notes:

Parameters copy function is only available by using the optional keypad.

- ◆ 1-Download parameters: all user parameters that stored in the keypad are copied from the keypad to the inverter.
- ◆ 2-Upload parameters: all user parameters are copied from the inverter to the keypad.
- ◆ 3-Download parameters except parameters of motors: all user parameters except parameters of motors are copied to the inverter.
- ◆ Parameter copying can only be executed by the optional keypad
- ◆ Parameter copying is started by setting PF.03. PF.03 will be set to 0 automatically when parameter copying finished. The user can operate the keypad after pressing the STOP key. The CCF3 would be produced if the EEPROM in the control board of the inverter is abnormal.

The following words would be displayed on the keypad.

Code	Interpretation	Code	Interpretation
dn0	Downloading parameters	dn1	Downloading parameters except motor's
uP	Uploading parameters	SUCC	Copying succeed
StP	Users pressed the STOP key	rEt	Retry over 3 times

Code	Interpretation	Code	Interpretation
EFLF	The mode and the Serial number is disaccord	bdAF	The date on the keypad is abnormal
rEF	Error occurred during downloading	UrtO	Timeout during the control board receiving data
brtO	Timeout during the keypad receiving data	LdtO	Timeout during copying parameters



Tips:

The user can copy the user parameter in the inverter from one unit to another unit by the optional keypad.

This function is available only when the models are just the same.

This function is available for 6000M-S2R4GB, S2R75GB which software version is V110 or above.

This function is also available for 6000M-S21R5GB, S22R2GB, 6000E which software version is V140 or above.

PF.04 G/P select	Setting range: 0, 1[0]
------------------	------------------------

0: Type G (Constant torque)

1: Type P (Inlet fan and pump series loads)

Note:

The parameter is only valid to the inverter of G/P series, otherwise it is always 0.

This parameter cannot be modified by PF.02.

- ◆ Default value of the inverter is 0. If want type P, please setting PF.04 to 1.

Example: When the inverter model is type G (such as 31R5GB), you want the inverter of 32R2PB (Type P), set PF.04 to 1.

Tips: By this way, you can get a type G inverter from a type P inverter.

PF.05 Application select	Setting range: 0, 1[0]
--------------------------	------------------------

0: General inverter

1: Rotary cutting machine

PF.09 Product series number	Setting range: 0~9999 [Depend on model]
PF.10 Software version number	Setting range: 0.00~99.99 [Depend on model]
PF.11 Non-standard version and serial number	Setting range: 0.000~9.999 [Depend on model]
PF.12 Software identification code	Setting range: 0~9999 [Depend on model]

Chapter 6 Troubleshooting

6.1 Troubleshooting

When the inverter has detected a fault, the keypad will display the fault code, and the inverter will stop PWM output and come into fault protection state. In the fault indicator TRIP will flicker, the fault relay has output and the motor will coast to stop. At this time, you should find the reason of fault and apply corrective actions. If the listed troubleshooting cannot solve the problem, please contact our company directly. After debugging, you can press “STOP/RESET” or reset external terminals to restart the inverter. Notes: the inverter can’t startup even through debugging has been finished if operating signal isn’t removed. You should cut operating signal first and then close again or remove main circuit power supply once to make the fault reset. If the SC fault appeared, the reset is only permitted after 10 seconds. If you want to see the work condition (such as output frequency, reference frequency, output current, bus voltage., etc) or contents of the latest three faults, please press “PRG/ESC ” to enter program state and then turn the knob to see parameter value of function code PE.00~PE.08.

Table 6-1 Troubleshooting

Fault Display	Name of Protection	Possible Cause to Fault	Countermeasure
Uu1	Busbar under-voltage	◆ The input voltage is abnormal	<ul style="list-style-type: none"> ● Check the voltage of power supply ● Check and test the electrical level setting
Uu3	The charging circuit is poor	◆ The contactor doesn't pull in.	<ul style="list-style-type: none"> ● Check the charging circuit
OC1	Overcurrent during the acceleration	<ul style="list-style-type: none"> ◆ The acceleration time is too short ◆ The V/F curve is not appropriate ◆ The power voltage is low ◆ The inverter power is too small ◆ The inverter output load is short-circuited. 	<ul style="list-style-type: none"> ● Increase the acceleration time ● Adjust the V/F curve setting and have the appropriate torque boost setting ● Check the input power supply ● Select the inverter with the larger power ● Check the motor coil resistance and the motor insulation

Fault Display	Name of Protection	Possible Cause to Fault	Countermeasure
OC2	Overcurrent during the deceleration	<ul style="list-style-type: none"> ◆ The deceleration time is too short ◆ The load inertia torque is large ◆ The inverter power is too small ◆ The inverter output load is short-circuited 	<ul style="list-style-type: none"> ● Increase the deceleration time ● Add the appropriate brake components additionally ● Select the inverter with the larger power ● Check the motor coil resistance and the motor insulation
OC3	Overcurrent during the constant-speed operation	<ul style="list-style-type: none"> ◆ Abnormal load ◆ The acceleration or deceleration time is set to be too short ◆ The power voltage is low ◆ The inverter power is too small ◆ The inverter output load is short-circuited 	<ul style="list-style-type: none"> ● Check the load ● Increase the acceleration or deceleration time appropriately ● Check the input power supply ● Select the frequency-inverter with the larger power ● Check the motor coil resistance and the motor insulation
Ou1	Overvoltage during the acceleration	<ul style="list-style-type: none"> ◆ The input voltage is abnormal ◆ The acceleration time is too short ◆ The stalling overvoltage point is too low 	<ul style="list-style-type: none"> ● Check the input power supply; check & test the electrical level setting ● Increase the acceleration time appropriately ● Raise the stalling overvoltage point

Fault Display	Name of Protection	Possible Cause to Fault	Countermeasure
Ou2	Overvoltage during the deceleration	<ul style="list-style-type: none"> ◆ The input voltage is abnormal ◆ The deceleration time is too short ◆ The load inertia torque is large ◆ The stalling overvoltage point is too low 	<ul style="list-style-type: none"> ● Check the input power supply; check & test the electrical level setting ● Increase the deceleration time appropriately ● Add the appropriate brake components additionally ● Raise the stalling overvoltage point
Ou3	Overvoltage during the constant-speed operation	<ul style="list-style-type: none"> ◆ The input voltage is abnormal ◆ The acceleration or deceleration time is too short ◆ The load inertia torque is large ◆ The stalling overvoltage point is too low 	<ul style="list-style-type: none"> ● Check the input power supply; check & test the electrical level setting ● Increase the deceleration time appropriately ● Add the appropriate brake components additionally ● Raise the stalling overvoltage point
GF	Output earthing	<ul style="list-style-type: none"> ◆ The output earthing current exceeds the specified value 	<ul style="list-style-type: none"> ● Check whether the motor insulation has become poor ● Check whether the connection line between the inverter and the motor is damaged

Fault Display	Name of Protection	Possible Cause to Fault	Countermeasure
OH1/ OH3	Heat radiator overheating Rectifier bridge overheat	<ul style="list-style-type: none"> ◆ The environment temperature is too high ◆ The air duct is blocked ◆ The fan works abnormally/ is damaged 	<ul style="list-style-type: none"> ● Reduce the environment temperature ● Clear the air duct ● Replace the fan
OL1	Motor overloaded	<ul style="list-style-type: none"> ◆ The inverter output exceeds the motor overload value ◆ The V/F curve is inappropriate ◆ The power grid voltage is too low ◆ The ordinary motor operates at the low speed and with the large load for a long time ◆ The motor stalls or the load becomes too large suddenly 	<ul style="list-style-type: none"> ● Reduce the load ● Adjust the V/F curve and the torque boost ● Check the power grid voltage ● Select the special motor ● Check the load
OL2	Inverter overloaded	<ul style="list-style-type: none"> ◆ The inverter output exceeds its overload value ◆ The DC brake quantity is too large ◆ The V/F curve is not appropriate ◆ The power grid voltage is too low ◆ The load is too large ◆ The acceleration time is too short ◆ The current limit level is too low 	<ul style="list-style-type: none"> ● Reduce the load and increase the acceleration time ● Reduce the DC brake current and increase the brake time ● Adjust the V/F curve and torque boost ● Check the power grid voltage ● Select the inverter with the larger power ● Increase the acceleration time ● Raise the current limit level

Fault Display	Name of Protection	Possible Cause to Fault	Countermeasure
SC	Load short-circuit/output earthing short-circuit	<ul style="list-style-type: none"> ◆ The inverter output load is short-circuited ◆ The output side earthing is short-circuited 	<ul style="list-style-type: none"> ● Check whether the connection cable between the inverter and the motor is damaged ● Check the motor coil resistance ● Check the motor insulation
EF0	External fault with the RS485 serial communication	<ul style="list-style-type: none"> ◆ The serial (MODBUS) transmission error 	<ul style="list-style-type: none"> ● Set the correct timeout detection time or set the Pb.03 timeout detection time as 0.0s ● Check the external control circuit ● Check the input terminal conditions. If terminals are not used but the fault is still displayed, please seek the technical support for settlement.
EF1	External fault with terminals X1~X6	<ul style="list-style-type: none"> ◆ Fault caused by the external control circuit 	<ul style="list-style-type: none"> ● Set the correct timeout detection time or set the Pb.03 timeout detection time as 0.0s ● Check the external control circuit ● Check the input terminal conditions. If terminals are not used but the fault is still displayed, please seek the technical support for settlement.
SP1	Input phase loss or imbalance	<ul style="list-style-type: none"> ◆ Input R, S & T phase loss or imbalance 	<ul style="list-style-type: none"> ● Check the input voltage ● Check the input connection line
SP0	Output phase loss or imbalance	<ul style="list-style-type: none"> ◆ Output U, V, W phase loss or imbalance 	<ul style="list-style-type: none"> ● Check the output connection line ● Check the motor and cable insulation

Fault Display	Name of Protection	Possible Cause to Fault	Countermeasure
CCF1	Control circuit fault 0	<ul style="list-style-type: none"> ◆ Transmission between the inverter and the keypad cannot be established within 5s after power is supplied (when power is just supplied) 	<ul style="list-style-type: none"> ● Re-connect the keypad ● Check the connection line ● Replace the keypad ● Replace the control board
CCF2	Control circuit fault 1	<ul style="list-style-type: none"> ◆ The -inverter and the keypad communicate once after power is supplied, but the transmission fault afterwards last for at least 2s (in operation) 	
CCF3	EEPROM fault	<ul style="list-style-type: none"> ◆ EEPROM fault with the control board of inverter 	<ul style="list-style-type: none"> ● Replace the control board
CCF4	AD conversion fault	<ul style="list-style-type: none"> ◆ AD conversion fault with the control board of inverter 	<ul style="list-style-type: none"> ● Replace the control board
CCF5	RAM fault	<ul style="list-style-type: none"> ◆ RAM fault with the control board of inverter 	<ul style="list-style-type: none"> ● Replace the control board
CCF6	CPU disturbance	<ul style="list-style-type: none"> ◆ Serious disturbance ◆ MCU reading & writing error with the control board ◆ The communication line is connected reversely or the DIP switch is at wrong position. 	<ul style="list-style-type: none"> ● Reset via the button “STOP/RESET” ● Add the power filter at the power side additionally ● Seek the technical support

Fault Display	Name of Protection	Possible Cause to Fault	Countermeasure
PCE	Parameter copying error	<ul style="list-style-type: none"> ◆ Error with the parameter copying between the keypad and EEPROM of the control board ◆ EEPROM of the control board is damaged 	<ul style="list-style-type: none"> ● Repeat the copying operation ● Replace the control board ● Seek the technical support
HE	Current detection fault	<ul style="list-style-type: none"> ◆ Fault with the inverter current detection circuit ◆ The Hall components are damaged 	<ul style="list-style-type: none"> ● Replace the inverter ● Seek the technical support

6.2 Warning Display and Explanation

After warning action, warning code is displayed and flickering, but the inverter is not in fault-protecting state. In other words, PWM output will not be closed off, fault relay will not act. In addition, the inverter would automatically return to prevent operation state after the warning cause is removed.

The following table lists different kinds of Warnings.

Table 6-2 Warning display and description

Alarm Display	Display Content	Description
Uu	Under-voltage detection	Under-voltage is detected. The inverter can still work in this case.
OLP2	Inverter overload pre-alarm	The inverter working current is over the overload detection level and the duration is over the overload detection time. In this case, the inverter can still work.
OH2/OH4	Heat radiator temperature too high	The heat radiator temperature is larger than the OH2/OH4 detection benchmark. In this case, the inverter can still work.
AE1/AE2	Analog signal 1/2 is abnormal	When the signal level of the analog signal is less than the minimum value or higher than the maximum value (0.2V) continuously for 500ms. (S2R4GB, S2R75GB have no AE2)

Alarm Display	Display Content	Description
SF1	Function code setting is inappropriate	For example, for the I/O terminal, SS0-2 and TT0-1 setting is not incomplete
SF2	The running mode selection is inconsistent with the terminal setting	The operation manner setting is inconsistent with the setting of terminal X1~X6.
AtE	Parameter auto-tune is abnormal	The parameter auto-tune is abnormal. The inverter will exit from the parameter tuning automatically.

6.3 Motor's Faults and Corrective Measure

If the motor has one of the following faults, please find the reason and take corresponding corrective measure. Seek for technical support if the measure does not work

Table 6-3 Motor fault and corrective measure

Fault	Check Content	Corrective Measures
The motor fails to run	Check whether the power is supplied to the power terminals R, S and T and whether the CHARGE LED indicator light is on.	<ul style="list-style-type: none"> ● Be connected to the power supply ● Disconnect the power supply and then be connected to it again. ● Check the power voltage ● Check whether the terminal screws have been tightened
The motor fails to run	Test whether the voltage of terminals U, V and W is correct with the rectifier voltmeter	● Disconnect the power supply and then be connected to it again.
	Check whether the motor has been locked due to overload	● Reduce the load and remove the lockout
	Check whether there is fault display on the keypad and whether the TRIP light is flickering	● Search Table 6-1 according to the fault codes
	Check whether there is the operation command	● Check whether the operating terminal connection lines are connected reliably
	Check whether the anti-reverse selection setting conflicts with the direction command	● Set the reverse allowing or change the direction command

Fault	Check Content	Corrective Measures
The motor fails to run	Check whether the terminal operation signal is disconnected first and then connected after the fault occurs	<ul style="list-style-type: none"> ● The terminal operation signal is disconnected first and then connected
	Check whether the given frequency voltage is input	<ul style="list-style-type: none"> ● Check the given frequency voltage
	Check whether the operation manner is set correctly	<ul style="list-style-type: none"> ● Input the correct setting
The motor rotates reversely	Check whether the connection lines of terminals U, V and W are correct	<ul style="list-style-type: none"> ● Adjust the corresponding connection lines of terminals U, V and W ● Adjust the function code P2.37
The motor rotates but cannot change the speed	Check whether the connection lines of frequency reference circuit are correct	<ul style="list-style-type: none"> ● Correct the connection lines
	Check whether the load is too large	<ul style="list-style-type: none"> ● Reduce the load or increase the acceleration or deceleration time
The motor rotating speed is too high or too low	Check whether the maximum output frequency setting value is correct	<ul style="list-style-type: none"> ● Check the maximum output frequency setting value
	Check whether the voltage drop between the motor terminals is too large with the rectifier voltmeter	<ul style="list-style-type: none"> ● Check the V/F characteristic value
The motor rotating speed is unstable during operation	Check whether the load is too large	<ul style="list-style-type: none"> ● Reduce the load
	Check whether the load variation is too large	<ul style="list-style-type: none"> ● Reduce the load variation
	Check whether there is phase loss with the three-phase power	<ul style="list-style-type: none"> ● Check whether there is phase loss with the connection lines of the three-phase power ● For the single-phase power, connect the AC reactor to the power supply
	The frequency giving source is unstable	<ul style="list-style-type: none"> ● Check the frequency giving source

Fault	Check Content	Corrective Measures
There is too much noise with the motor	The bearing is worn, lubrication is poor , and the rotor is eccentric	● Repair the motor
	The carrier frequency is too low	● Increase the carrier frequency
There is too large vibration with the motor	Mechanical resonance	● Adjust the leaping frequency
	The machine legs are not even	● Adjust the machine legs
	The three-phase outputs are imbalanced	● Check the inverter output

Chapter 7 Peripheral Equipment

7.1 Peripheral Equipment Connection Diagrams

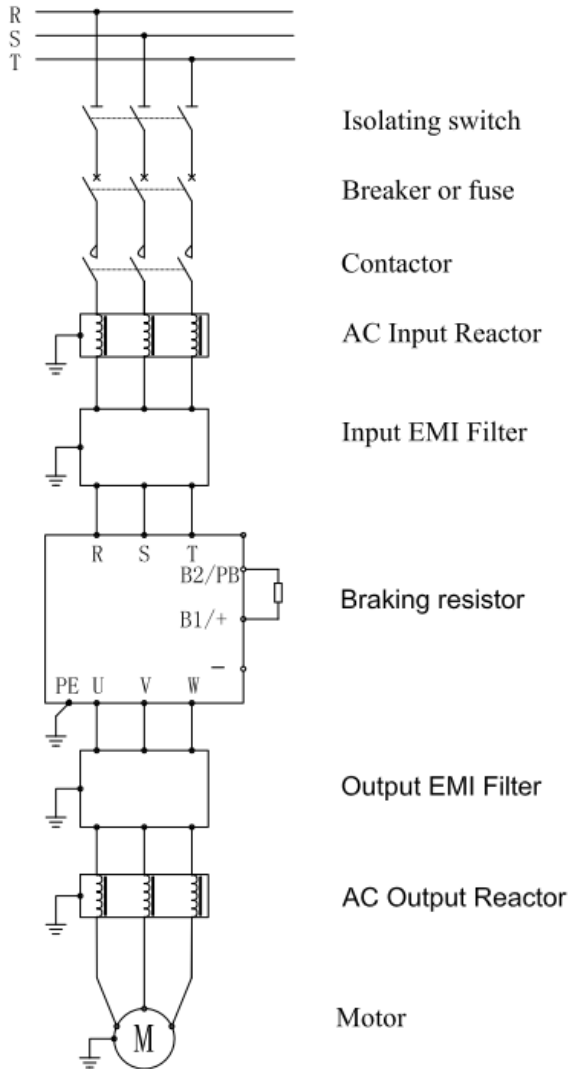

Fig. 7-1 S2R4GB~3015GB/3018PB Peripheral Equipment Connection Diagram

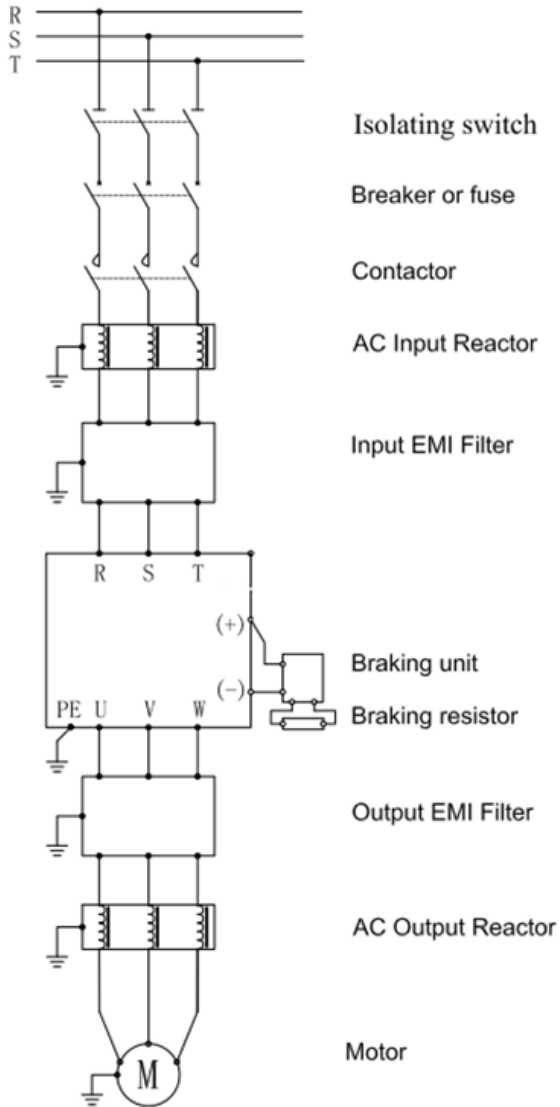

Fig. 7-2 3018G/3022P and above Peripheral Equipment Connection Diagram

7.2 Function of Peripheral Equipment

Table 7-1 Function of Peripheral Equipment

Peripheral Equipment & Optional parts	Description
Breaker	It is used to cut off the fault current of the inverter rapidly and prevent the power fault caused by fault with the inverter and its circuits.
Contactors	It is used to cut off the main power supply at the time of inverter fault and prevent power failure & restarting after the fault
* AC Reactor	It is used to improve the input power factor, reduce the higher harmonic and inhibit the power surge
* EMI Filter	It is used reduce the radio disturbance caused by the inverter. When the wiring distance between the motor and the inverter is less than 20m, it is suggested to be connected to the power supply side; when the distance is over 20m, is suggested to be connected at the output side.
* Braking Unit and Braking resistor	They are selected and used when the braking torque cannot meet the requirements, and are applicable on occasions of high-inertia load & frequent braking or rapid stop.

Remarks: *-marked items are optional parts.

7.2.1 AC Input Reactor

Using AC input reactor can restrain higher harmonic wave and improve power factor obviously. In the following situation, users are advised to use ac reactor.

- ◆ Power supply capacity: Inverter capacity>10: 1
- ◆ Silicon controlled load and switching controlled power factor compensator are on the same power supply line.
- ◆ Degree of three-phase voltage imbalance is more than 3%

7.2.2 Braking Unit and Braking resistor

Brake units are in-built in this series of inverters whose power rating is 15kW and below. When dynamic braking is required, the user just has to connect the braking resistor. There are not in-built brake units with the inverters of 18kW and above. When the dynamic braking is required, the additional braking unit should be connected. The braking unit consists of the control part, the driving part and the discharging resistance. The control part should be adjusted according to the overvoltage protection action values for this series of inverters. If the discharging resistance part is provided with the overheating protection, it is suggested that the controlling connection point be connected to the main control circuit.

Refer to the following table for common braking resistors specifications.

Table 7-2 Motor power and brake resistor selection

Voltage (V)	Motor Power (kW)	Resistance Value (Ω)	Resistance Power (kW)	Voltage (V)	Motor Power (kW)	Resistance Value (Ω)	Resistance Power (kW)
Single-phase 220V	0.4	200	0.1	Three-phase 380V	18.5	30	4
	0.75	150	0.2		22	30	4
	1.5	100	0.4		30	20	6
	2.2	75	0.5		37	16	9
Three-phase 380V	0.75	300	0.4		45	13.6	9
	1.5	300	0.4		55	20/2	12
	2.2	200	0.5		75	13.6/2	18
	4	200	0.5		93	20/3	18
	5.5	100	0.8		110	20/3	18
	7.5	75	0.8		132	20/4	24
	11	50	1		160	13.6/4	36
	15	40	1.5				

At braking, the regenerated energy of motor is almost consumed on the braking resistor. The braking power can be calculated according to the following formula:

$$U * U / R = P_b$$

In the formula, R is the value of selected braking resistor, U is the braking voltage at stable braking of the system (it varies with different systems; for the 380VAC system, it is generally taken as 700V), and P_b is the braking power. Theoretically, the power of braking resistor is the same with the braking power, but generally 70% of it will be used. Power required by the braking resistor can be calculated according to the following formula:

$$0.7 * P_r = P_b * D$$

In the formula, P_r is power of the braking resistor, and D is the braking frequency (proportion of the regeneration process in the whole working process), which can be selected according to the following table:

Table 7-3 Reference for Braking Frequency

Application Occasion	Elevator	Uncoiling & Coil Taking	Centrifuge	Accidental Braking Load	General Application
Braking Frequency	20%~30%	20~30%	50%~60%	5%	10%

7.2.4 Leakage Protector

There is direct earth safety capacitor or distributed capacitor inside the inverter, the

motor and with the input & output lead wires. At the same time this series of inverters is of low-noise type, and the higher carrier wave is used. Thus, the earth leakage current of the inverter is large, which is more obvious for the large capacity inverters. Sometimes, it may cause mistaken action of the leakage protection circuit.

In the above cases, not only the carrier frequency should be reduced appropriately, the lead wire should be shortened and the output reactor as well as the leakage protector should be installed. When the protector is installed, attention should be paid to the following points:

The leakage protector should be installed at the input side of inverter and had better behind the breaker.

The leakage protector functioning current should be 10 times larger than the leakage current of this circuit under the fundamental frequency power supply and with the inverter unused (total leakage current of circuits, EMI filter and motor, etc).

7.2.5 Capacitor Box

This optional device is applied specially on occasions where continuous operation is required as there is relative long momentary power off over 20ms. It can be purchased from our company. In the purchase order, please specify the actual load and the continuous operation time required after power off, so we can manufacture it appropriately.

As the capacitance box may influence some parameters in inverter after it is assembled, the purchasing without our instruction is not recommended.

Chapter 8 Maintenance



Danger

1. Please do not touch the terminals of inverter, which are provided with the high voltage.
There is the danger of electric shock.
2. Before power is supplied, please do install the terminal casing well. When the casing is dismantled, please do cut off the power supply.
There is the danger of electric shock.
3. Maintenance and inspection cannot be started until the main circuit power supply is cut off and the CHARGE LED indicator light is confirmed to go out.
There is the danger of residual voltage on the electrolytic capacitor.
4. Non-professionals are not allowed to do the job of maintenance and inspection.
There is the danger of electric shock.



Caution

1. As the CMOS integrated circuit is installed on the keypad panel, the control circuit board and the driving circuit board, please pay special attention when they are used. If the circuit boards are touched with the finger directly, the integrated chips on them may be damaged by the electrostatic induction.
2. Please do not change the connection lines or dismantle the terminal lines when power is supplied.
There is the danger of electric shock.
3. Please do not check the signal during operation. Otherwise, the equipment may be damaged.

8.1 Inspection and Maintenance

Inverter is a typical product which combines the power electronics technology with the microelectronics technology. Therefore, it double features with industrial Equipment and microelectronics Equipment. The change of environment such as temperature, humidity, smog and internal components aging will cause kinds of faults to the inverter. For long time reliable operation, daily inspection and regular maintenance (at least 3 or 6 months interval) is needed.

8.1.1 Daily Inspection

Before inverter running, please check below:

- ◆ Whether there is abnormal sound or vibration with the motor;

- ◆ whether the inverter and the motor heat up abnormally;
- ◆ whether the environment temperature is too high;
- ◆ whether the load ammeter indicates the same value as usual;
- ◆ whether the cooling fan of inverter operates normally;
- ◆ Whether the braking resistor has the good earthing insulation.

The daily maintenance and inspection content is showed in Table 8-1.

Table 8-1 Content and Notice for Daily Maintenance & Inspection

No.	Inspection Item	Inspection Part	Inspection Content	Judgment Standard
1	Display	LED Monitor	Whether the display is abnormal.	Determine according to the use state (e.g. when nothing is displayed after power is supplied, the braking resistor and the earthing insulation can be checked)
2	Cooling System	Fan	Check whether it rotates flexibly, whether there is abnormal sound, and whether it is jammed by dust.	No abnormality
3	Inverter Body	Inside the Machine Case	Temperature rising, abnormal sound, peculiar smell and accumulated dust	No abnormality
4	Working Environment	Surrounding Environment	Temperature, humidity, dust and harmful gas, etc	According to Clause 2.2
5	Voltage	Input & Output Terminals	Input and output voltage	According to the technical specifications in Appendix 2
6	Load	Motor	Temperature rising, abnormal sound and vibration	No abnormality

8.1.2 Regular Maintenance

The power supply must be cut off before regular maintenance. Only after the monitor has no display and charge LED has gone off 5~10 minutes can the maintenance begin. Otherwise, you will risk electric shock because there are storage capacitors within the inverter that will hold charge even after the input power is disconnected.

The regular maintenance contents and cautions are listed in Table 8-2.

Table 8-2 Content of Regular Maintenance & Inspection

Inspection Item	Inspection Content	Countermeasure
Screws of main circuit terminals and control circuit terminals	whether the screws are loosened	Tighten them with the screwdrivers
Heat Radiator	whether there is dust	Purge it with the 4~6kg/cm ² dry compressed air
PCB (Printed Circuit Board)	whether there is dust	Purge it with the 4~6kg/cm ² dry compressed air
Cooling Fan	whether it rotates flexibly, whether there is abnormal sound or vibration, and whether there is accumulated dust or blocking object	Replace the cooling fan and clear the dust & foreign objects
Power device	whether there is dust	Purge it with the 4~6kg/cm ² dry compressed air
Electrolytic Capacitor	Check whether there is color variation, peculiar smell, bubbles and liquid leaked, etc.	Replace the electrolytic capacitor
Braking resistor	whether the earthing insulation is good	Put the braking resistor at the dry and insulated place

During the inspection, elements cannot be dismantled or shaken casually. Moreover, connectors cannot be pulled out casually. Otherwise, the inverter may not be able to run normally or may enter the fault display state. Even, components faults may be caused or the main switch device IGBT module or other elements may be damaged.

When measurement is required, it should be noted that results with great difference may be got with different instruments. It is recommended that the moving-coil voltmeter be used to measure the input voltage, the bridge voltmeter be used to measure the output voltage, clamp-on ammeter be used to measure the input & output current, and the electric wattmeter be used to measure the power. If conditions are inadequate, the same meter can be used for measurement and record should be reserved to facilitate comparison.

If the waveform test is required, it is suggested the oscilloscope with the scanning frequency larger than 40MHz be used. When the instantaneous waveform is tested, the oscilloscope with the frequency over 100MHz should be used. Before the test, electric isolation should be done for the oscilloscope.

In the case of serious power supply asymmetry or three-phase current imbalance, it is suggested the three-wattmeter method be used to measure the power.

As the electric insulation test and the dielectric strength test have been done for the product before it leaves the factory, the users don't have to do such tests again. Moreover, such tests will reduce the insulation and voltage withstand performance of the product. If such tests are conducted inappropriately, product elements may even be

damaged. If such tests have to be done really, it is suggested they be conducted by the skilled technicians.

If the main circuit voltage withstand test is to be done, the withstand voltage tester with the time & leakage current settable and the similar capacity should be used. The test may reduce the life of product. If the main circuit insulation test is to be done, the main circuit terminals R, S, T, U, V, W, PB(P1), + and – etc should be short-circuited reliably and then the meg-ohmmeter with the near voltage grade (250V for 220V, 500V for 380V, and 1000V for 660V) should be used for measurement. The control circuit should be measured with the resistance shift of the universal meter instead of the meg-ohmmeter.

For the 380V main circuit, the ground insulation resistance should not be less than 5 MΩ; for the control circuit, the ground insulation resistance should not be less than 3 MΩ.

8.1.3 Regularly-replaced Elements

To ensure the long-term and reliable operation of inverter, regular care and maintenance should be carried out for internal electronic elements of the inverter. The life of these electronic elements varies with the environment and conditions where the inverters are used. Generally, if the inverter is used continuously, the elements can be replaced according to the following table, which also depends on the using environment, load conditions and inverter state, and other specific conditions. As showed in Table 8-3, the maintenance term is just for user’s reference when it is used.

Table 8-3 Replacement Time for Wearing Elements of Inverter

Name of Element	Standard Years for Replacement
Cooling Fan	2~3 years
Electrolytic Capacitor	4~5 years
Printed Circuit Board	5~8 years

8.2 Storage and Protection

If the inverter is not used immediately after purchased and has to be stored temporarily or permanently, the following should be done:

- ◆ It should be put in the place within the specified temperature & humidity scope, without damp, dust and metal dust, and with good ventilation.
- ◆ If it is unused for over one year, the charging test should be conducted to restore the characteristics of electrolytic capacitor of the main circuit. During charging, the input voltage of the inverter should be increased to the rating value slowly with the voltage regulator. The energizing time should be at least 1~2 hours.
- ◆ The above test should be conducted at least once a year.
The voltage withstand test cannot be conducted casually, as it will reduce the life of inverter and even damage the elements. For the insulation test, the 500V mega-ohmmeter whose insulation resistance is not less than 4 MΩ can be used.

Appendix 1 External Dimension and Installation Dimension

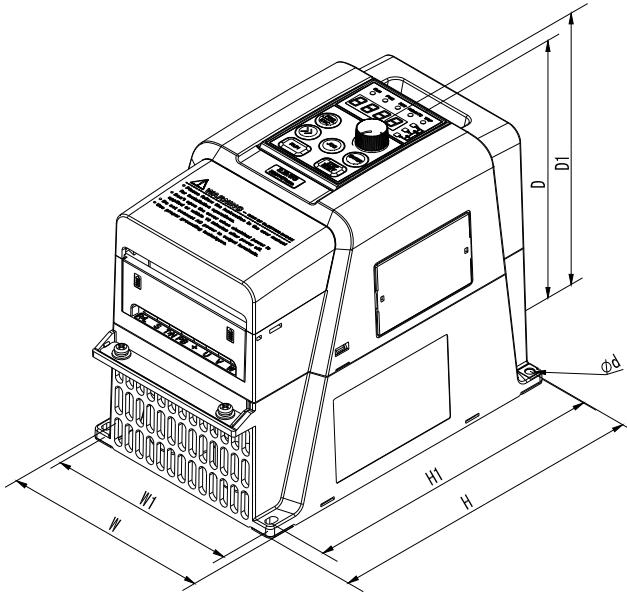

Fig. A1-1 Schematic outline

Table A1-1 External Dimension (unit: mm)

Specifications	H	H1	W	W1	D	D1	d
S2R4GB~S2R75GB	145	135	90	82	125	135	4.5
S21R5GB~S22R2GB 3R75GB/31R5PB~32R2GB/3004PB	198	175	120	110	150	160	4.5
3004GB/35R5PB	210	182	130	119	162	172	4.5
35R5GB/37R5PB~37R5GB/3011PB	255	238	180	166	174	183	7

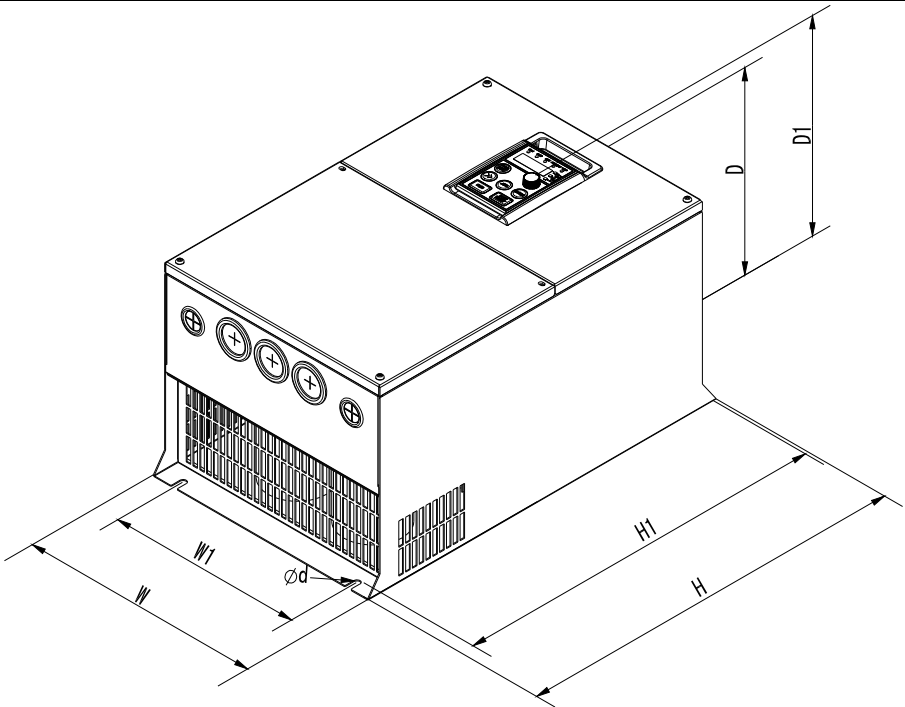

Fig. A1-2 Schematic outline

Table A1-2 External Dimension (unit: mm)

Specifications	H	H1	W	W1	D	D1	d
3011GB/3015PB~ 3015GB/3018PB	375	360	235	193	180	190	8
3018G/3022P~3030G/3037P	460	440	285	230	235	245	8
3037G/3045P	535	520	320	180	230	248	8
3045G/3055P~3055G/3075P	540	522	360	230	274	292	8
3075G/3093P~3093G/3110P	657	630	438	318	280	299	10
3110G/3132P~3160G/3185P	804	782	520	420	355	374	10

Appendix 2 Technical Specifications

Inverter model information

Series	Model	Input Voltage	Power capacity (kVA)	Input current (A)	Output current (A)	Matching Motor Power (kW)
ALPHA6000M	S2R4GB	Single-Phase 220V: 176~264V, frequency imbalance rate<±5%	1.0	5.1	2.4	0.4
	S2R75GB		1.7	9.2	4.5	0.75
	S21R5GB		2.8	13.1	7.0	1.5
	S22R2GB		4.0	23	10.0	2.2
ALPHA6000E	3R75GB	Three-phase 380V: 304~456V, voltage imbalance rate<3%, frequency imbalance rate<±5%	1.6	3.7	2.5	0.75
	31R5GB/31R5PB		3.2	5.4	4.0	1.5
	32R2GB/32R2PB		4.8	7.0	6.0	2.2
	3004GB/3004PB		6.0	10.7	9.0	4
	35R5GB/35R5PB		8.6	15.5	13.0	5.5
	37R5GB/37R5PB		11.2	20.5	17.0	7.5
	3011GB/3011PB		17.0	26.0	25.0	11
	3015GB/3015PB		21.0	35.0	32.0	15
	3018G/3018PB		24.0	38.5	37.0	18.5
	3022G/3022P		30.0	46.5	45.0	22
	3030G/3030P		40.0	62.0	60.0	30
	3037G/3037P		50.0	76.0	75.0	37
	3045G/3045P		60.0	92.0	90.0	45
	3055G/3055P		72.0	113.0	110.0	55
	3075G/3075P		100.0	157.0	152.0	75
	3093G/3093P		116.0	180.0	176.0	93
	3110G/3110P		138.0	214.0	210.0	110
3132G/3132P	167.0	256.0	253.0	132		
3160G/3160P	200.0	307.0	304.0	160		
3185P	230.0	350.0	342.0	185		

Other technical specifications

Rated Output Voltage	0~Rated input voltage
Maximum Overload Current	Type G: 150% 1minute, 180% 20s Type P: 120% 1minute, 150% 1s
Control Mode	V/F control, open-loop vector control
Frequency Control Scope	low frequency mode: 0.00~400.0Hz high frequency mode: 0.0~1000Hz(reserve)

Appendix 2 Technical Specifications

Frequency Precision	digital command $\pm 0.01\%$ ($-10^{\circ}\text{C}\sim+40^{\circ}\text{C}$) analog command $\pm 0.01\%$ ($25^{\circ}\text{C}\pm 10^{\circ}\text{C}$)
Set Frequency Resolution	digital command 0.01Hz; analog command 1/1000 maximum frequency
Output Frequency Resolution	0.01Hz
Frequency Setting Signal	0~10V, 0~20mA
Acceleration & Deceleration Time	0.1~3600s (acceleration and deceleration time are set independently)
Braking Torque	reach 125% with additional braking resistor
Voltage/Frequency Characteristic	4 types of fixed V/F characteristics are optional; any V/F characteristic can be set; with the PG V/F control
Protection Function	overvoltage, under-voltage, current limit, overcurrent, overload, electronic thermal relay, overheat, overvoltage stalling, load short circuit, earthing, under-voltage protection, input phase loss, output phase loss, earthing and interphase short circuit, and motor overload protection, etc
Ambient Environment Temperature	$-10^{\circ}\text{C}\sim+40^{\circ}\text{C}$
Humidity	5~95% RH (without condensation)
Storage Temperature	$-40^{\circ}\text{C}\sim+70^{\circ}\text{C}$
Application Site	indoors (without corrosive gas)
Installation Site	With the altitude not more than 1000m, and free of dust, corrosive gas and direct sun shining. Deration 6% per 1000 meters above 1000m.
Vibration	$< 5.9\text{m/s}^2(0.6\text{g})$
Protection Class	IP20

Appendix 3 Use of MODBUS Communication

These series inverters can use the programmable logic controller (PLC) and other upper devices to conduct the data exchange through MODBUS communication protocol.

- **Constitution of MODBUS Communication**

The communication data bus consists a main controller (PLC) and 1~31 inverters. The signal is transmitted from the main controller and the inverter responds to it.

The main controller conducts the signal transmission with maximum 31 inverters. All inverters should have their own address codes. The main controller transmits signals according to the specified codes. The inverters will function after receiving the commands from the main controller and feedback the response to the main controller.

- **Communication Standard**

Interface	RS-485
Communication Manner	Asynchronous and half-duplex
Communication Parameters	Speed: selected from 1200/2400/4800/9600/19200/38400bps Parity Check Selection: even / odd/ none Data length: RTU mode - 8 bits fixed, ASCII mode- 7 data or 8 data. Stop Bit: RTU mode-1 bit fixed, ASCII mode- 1 bit if the parity is active, 2 bits if no parity.
Communication Protocol	MODBUS-RTU Mode, ASCII mode (Reserve)
Number of Connectable Inverters	31

Description of the communication connecting terminal

MODBUS communication uses 485+ and 485- terminals. Besides, the control board of S2R4GB and S2R75GB is equipped with terminal resistors: when multiple inverters in this series are connected using RS485 bus communication, from the perspective of PLC, the inverters regarded as the terminal should keep its SW2 at ON position.

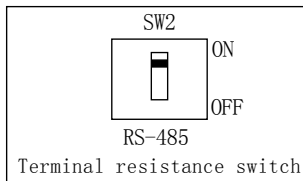

- **Notice for Wring**

- (1) The communication cables should be separated from the main circuit cables, other power cables and electric cables.

- (2) Shielded cables should be used as the communication cables. The shielding layer should be connected to the earthing terminal of inverter, while the other end will not be connected. (To prevent malfunction caused by disturbance)

The sequence to have communication with PLC is as follows:

1. When the power supply is cut off, connect the communication cable between PLC and inverter.
2. Supply the power.
3. Set the parameters required by communication on the keypad (Pb.00~Pb.08).
4. Cut off the power supply and wait until keypad display disappears completely.
5. Switch on the power supply again.
6. Conduct the communication with PLC.

- **Setting of Communication Parameters**

To communicate with PLC, communication-related parameters should be set. Include P0.03, P0.04, P0.07, P0.11, P7.00, P7.01, P7.03, P7.04, P8.11, P9.19, Pd.02, Pd.04, Pb.00~Pb.06. Please refer to Chapter 4 and Chapter 5 for details.

*Note 1: Only when the “Communication setting” passage is selected, can the command be written into the corresponding register. Otherwise, 02h will be reported.

*Note 2: If the Baud rate selection and the parity check selection are revised, new setting will not become effective until the inverter is stopped first and then restarted. Setting of these two items for the upper and lower computers should be the same. Otherwise, communication cannot be established or there will be errors with communication.

*Note 3: When the inverter address is set as 0, the inverter will not receive the communication command, including the broadcast command. When the inverter address is larger than 0, the new address will become effective once it is revised.

- **Transmission Period Limit**

In order to reduce the packet loss ratio caused by the communication disturbance and get the best communication effect, please limit the data transmission period in the host station to ensure both data transmission and receiving are normal. With the even parity check manner selected, the user can obtain the quickest communication response.

- **Command Formatting**

During communication, the main controller (PLC, etc) gives commands to inverters, and the inverters respond to them. As the command function content varies, the length of data will vary as well. MODBUS protocol support both RTU and ASCII mode.

1. RTU mode

The process constitutes the information transmission & receiving as showed in the following figure. The interval between two commands should maintain the time recorded below.

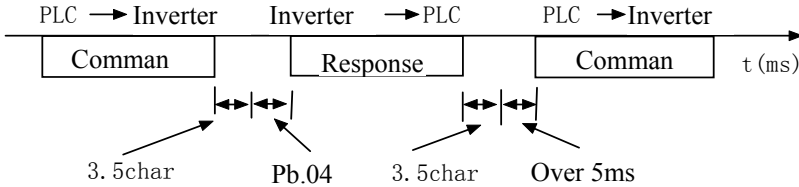

The frame format is illustrated as follows:

Start	Inverter address	Command Code	data	CRC	End
The interval is more than 3.5 char	1 char	1 char	n char	2 char	The interval is more than 3.5char

Under RTU mode, the checksum adopts CRC-16 method. All data except checksum itself sent will be counted into the calculation.

The calculation method for CRC-16 used by MODBUS communication is as follows:

- 1) Generally, when CRC-16 is calculated, its initial value is 0, and the initial value of the communication terminal series is set as 1. (1 for 16 bits)
- 2) LSB according to the inverter address is MSB, and the final data MSB uses LSB to calculate CRC-16.
- 3) The response command of inverter also has to calculate CRC-16 to be compared with CRC-16 in the response command.

2. ASCII mode

In ASCII mode, the frame head is “0x3A”, and frame tails “0x0D” and “0x0A”. Except frame head and tail, hexadecimal “0”~“9” and “A”~“F” are available, these bytes will be sent as two ASCII characters, first sending higher nibble and then lower nibble. “A”~“F” corresponds to the ASCII code of respective capital letter. LRC check is used. LRC checksum is calculated by adding all the successive 8 bit bytes of the message except the head and tail, discarding any carriers, and then complementing the result. The transmitted time of a frame should be no more than 1s, and the respond delay time should be no less than 1ms.

The frame format is illustrated as follows:

Start	Inverter address	Command Code	Data	LRC	End
1 char (3AH)	2 char	2 char	n char	2 char	2 char (0DH, 0AH)

Inverter address: inverter address (0 ~ 31)

When it is set as 0, commands are transmitted together in the broadcast manner. Even if the broadcast command is received, the inverter will not give response.

● **Command Code**

There are four types of MODBUS command codes supported by the series of inverters, which are showed as follows:

Command Code (16 bits)	Function	Command Length (BYTE)		Normal Response Length(BYTE)		Abnormal Response Length (BYTE)	
		Minimum	Maximum	Minimum	Maximum	Minimum	Maximum
03H	Reading Record	8	8	7	7	5	5
06H	Single Character Writing	8	8	8	8	5	5
08H	Loopback Test	8	8	8	8	5	5
10H	Writing Record	11	11	8	8	5	5

● **Example of Command Application**

Note: all data below is hexadecimal.

[03H]

Reading of Single-character Command: read the single-character record content from the specified code. The record content is divided into high 8 bits and low 8 bits and becomes part of the response content in order.

Example: read the state of inverter 1

RTU mode:

Command Content			Normal Response Content			Abnormal Response Content		
Inverter Address		01	Inverter Address		01	Inverter Address		01
Command Code		03	Command Code		03	Command Code		83
Start Address	High Bit	00	Number of Data		02	Abnormality Code		03
	Low Bit	20	Content of Data	High Bit	00	CRC	High Bit	01
Number of Addresses	High Bit	00		Low Bit	C1		Low Bit	31
	Low Bit	01	CRC	High Bit	79			
CRC	High Bit	85		Low Bit	D4			
	Low Bit	C0						

Notes: The number of data doubles that of address.

ASCII:

Command Content: 3A 3031 3033 3030 3230 3030 3031 4442 0D0A (LRC: DB)

Normal Response: 3A 3031 3033 3032 3030 4331 3339 0D0A (LRC: 39)
 Abnormal Response: 3A 3031 3833 3033 3739 0D0A (LRC: 79)

[06H]

Single-character Writing Command: write a single character into the specified register, and save the specified data in the specified register. The data saved should be among the order of record codes. The command content should be arrayed in the sequence of high 8 bits and low 8 bits.

Example: start the operation of inverter 1

RTU mode:

Command Content			Normal Response Content			Abnormal Response Content		
Inverter Address	01		Inverter Address	01		Inverter Address	01	
Command Code	06		Command Code	06		Command Code	86	
Start Address	High Bit	00	Start Address	High Bit	00	Abnormality Code	00	
	Low Bit	01		Low Bit	01			
Content of Data	High Bit	00	Content of Data	High Bit	00	CRC	High Bit	42
	Low Bit	01		Low Bit	01		Low Bit	60
CRC	High Bit	19	CRC	High Bit	19			
	Low Bit	CA		Low Bit	CA			

ASCII:

Command Content: 3A 3031 3036 3030 3031 3030 3031 4637 0D0A (LRC: F7)
 Normal Response: 3A 3031 3036 3030 3031 3030 3031 4637 0D0A (LRC: F7)
 Abnormal Response: 3A 3031 3836 3032 3737 0D0A (LRC: 77)

[08H]

Loop Test Command: the command content is fed back originally in the form of response and is used for test of signal transmission and returning between the main controller and the inverter. Arbitrary values can be used as the test code and data.

Example: loop feedback test

RTU mode:

Command Content			Normal Response Content			Abnormal Response Content		
Inverter Address	01		Inverter Address	01		Inverter Address	01	
Command Code	08		Command Code	08		Command Code	88	
Test Code	High Bit	00	Test Code	High Bit	00	Abnormality Code	03	
	Low Bit	00		Low Bit	00			
Test Data	High Bit	12	Test Data	High Bit	12	CRC	High Bit	06
	Low Bit	34		Low Bit	34		Low Bit	01
CRC	High Bit	ED	CRC	High Bit	ED			
	Low Bit	7C		Low Bit	7C			

ASCII:

Command Content: 3A 3031 3038 3030 3030 3132 3334 4231 0D0A (LRC: B1)
 Normal Response: 3A 3031 3038 3030 3030 3132 3334 4231 0D0A (LRC: B1)
 Abnormal Response: 3A 3031 3838 3033 3734 0D0A (LRC: 74)

[10H]

Single-character Writing Command: write the content into the specified register, and write the specified data in the specified register. The data saved should be among the order of record codes. The command content should be arrayed in the sequence of high 8 bits and low 8 bits.

Example: set the frequency as 50.00Hz

RTU mode:

Command Content		Normal Response Content		Abnormal Response Content	
Inverter Address	01	Inverter Address	01	Inverter Address	01
Command Code	10	Command Code	10	Command Code	90
Start Address	High Bit	00	Start Address	High Bit	00
	Low Bit	02		Low Bit	02
Number of Addresses	High Bit	00	Number of Addresses	High Bit	00
	Low Bit	01		Low Bit	01
Number of Data	02	CRC	High Bit	A0	CRC
Content of Data	High Bit		13	Low Bit	
	Low Bit	88	CRC	High Bit	0C
AA		Low Bit		01	
CRC	High Bit	AA	CRC	High Bit	0C
	Low Bit	E4		Low Bit	01

Notes: The number of data doubles that of address.

ASCII:

Command Content: 3A 3031 3130 3030 3032 3030 3031 3032 3133 3838 3446 0D0A (LRC: 4F)
 Normal Response: 3A 3031 3130 3030 3032 3030 3031 4543 0D0A (LRC: EC)
 Abnormal Response: 3A 3031 3930 3033 3643 0D0A (LRC: 6C)

[10H]

Data Saving Command: write the MODBUS register address corresponding to the function parameters into the special saving address of 0xFF, and save the parameter content into EEPROM. It is equivalent to ENTER of the keypad to save the data without being lost at power failure. The command content is arrayed in the order of high 8 bits and low 8 bits. 00FFH is specially used for data saving and is effective when Pb.06=0.

Example: set the frequency as 30.0Hz and save it in EEPROM.

RTU mode:

Command Content			Normal Response Content			Abnormal Response Content		
Inverter Address		01	Inverter Address		01	Inverter Address		01
Command Code		10	Command Code		10	Command Code		90
Start Address	High Bit	01	Start Address	High Bit	00	Abnormality Code		23
	Low Bit	02		Low Bit	FF			
Number of Addresses	High Bit	00	Number of Addresses	High Bit	00	CRC	High Bit	0D
	Low Bit	01		Low Bit	01		Low Bit	D9
Number of Data		02	Number of Data		02			
Content of Data	High Bit	0B	Content of Data	High Bit	01			
	Low Bit	B8		Low Bit	02			
CRC	High Bit	B1	CRC	High Bit	B3			
	Low Bit	D2		Low Bit	CF			

ASCII:

Command Content: 3A 3031 3130 3031 3032 3030 3031 3032 3042 4238 3236 0D0A (LRC: 26)

Normal Response: 3A 3031 3130 3030 4646 3030 3031 3032 3031 3032 4541 0D0A (LRC: EA)

Abnormal Response: 3A 3031 3930 3233 3443 0D0A (LRC: 4C)

[10H]

Two Commands Writing: it can operate the two registers of 0001 action command and 0002 frequency setting 1. It should be noted that the operation command giving manner setting (P0.07) should be “serial communication” and that the frequency setting source 1 (P0.03) should be “communication setting”.

Example: set the frequency as 50.0Hz.

RTU mode:

Command Content			Normal Response Content			Abnormal Response Content		
Inverter Address		01	Inverter Address		01	Inverter Address		01
Command Code		10	Command Code		10	Command Code		90
Start Address	High Bit	00	Start Address	High Bit	00	Abnormality Code		03
	Low Bit	01		Low Bit	01			
Number of Addresses	High Bit	00	Number of Addresses	High Bit	00	CRC	High Bit	0C
	Low Bit	02		Low Bit	02		Low Bit	01
Number of Data		04	CRC		10			
Content of Data	High Bit	00			08			
	Low Bit	01						
	High Bit	13						
	Low Bit	88						
CRC	High Bit	6E						
	Low Bit	F5						

Notes: The number of data doubles that of address.

Appendix 3 Use of MODBUS Communication

ASCII:

Command Content: 3A 3031 3130 3030 3031 3030 3032 3034 3030 3031 3133 3838
 3443 0D0A (LRC: 4C)

Normal Response: 3A 3031 3130 3030 3031 3030 3032 4543 0D0A (LRC: EC)

Abnormal Response: 3A 3031 3930 3033 3643 0D0A (LRC: 6C)

● List of Data:

Command Data (writable)

MODBUS Address	Name	bit	Content
0000H		(Reserved)	
0001H	Operati- on Signal	0	Operation Command 1: Operation 0: Stop
		1	Reverse Command 1: Reverse 0: Forward
		2	External Fault 1: External Fault (EFO)
		3	Fault Resetting 1: Fault Resetting Command
		4	Multi-functional Input Command 1 (P3.01 X1 Terminal Function)
		5	Multi-functional Input Command 2 (P3.02 X2 Terminal Function)
		6	Multi-functional Input Command 3 (P3.03 X3 Terminal Function)
		7	Multi-functional Input Command 4 (P3.04 X4 Terminal Function)
		8	Multi-functional Input Command 5 (P3.05 X5 Terminal Function)
		9	Multi-functional Input Command 6 (P3.06 X6 Terminal Function)
	A~F	Reserved (See below Note 1)	
0002H	Frequency Setting 1 (Note 2)		
0003H	Communication PID feedback 1, data scope 0~2000 corresponding to -100.0%~100.0%		
0004H	Communication PID setting 1, data scope 0~2000 corresponding to -100.0%~100.0%		
0005H	Frequency Setting 2 (Note 2)		
0006H	PID feedback 2, data scope 0~2000 corresponding to -100.0%~100.0%		
0007H	PID setting 2, data scope 0~2000 corresponding to -100.0%~100.0%		
0008H	Upper limiting frequency, data scope 0~1000 corresponding to 0.0~100.0%, 100.0% corresponding to the upper limiting frequency		

MODBUS Address	Name	bit	Content
0009H	Stop DC braking current, data scope 0~1000 corresponding to 0.0~100.0%		
000AH	Driving torque setting, data scope 0~1000 corresponding to 0.0~100.0%, 100.0% corresponding to twice of the motor rated torque		
000BH	Output voltage bias, data scope 0~1000 corresponding to 0.0~100.0%, 100.0% corresponding to the maximum output voltage		
000CH	Motor protection sensor input passage		
0012H	Braking torque setting, data scope 0~1000 corresponding to 0.0~100.0%, 100.0% corresponding to twice of the motor rated torque		
0013~001FH	Reserved		

Note 1: write “0” in the reserved BIT.

Note 2: when the communication frequency command is > the maximum frequency, the abnormality code 21H “Beyond the Upper & Lower Limit” will be reported and the operation frequency will be reserved unchanged.

Note 3: addresses of 000DH~0011H and 0013H~001FH are reserved in the general inverter.

Note 4: when the above reserved register addresses are read, address error will be fed back.

Parameters Saving [Input Command] (Writable)

Record	Name	Content	Setting Range	Initial Value
00FFH	Input Command	MODBUS address in the function list	0100H ~ 0FFFH	—

Notes:

For the data writing command 06 and 10, only the data are written into RAM for operation and are effective for this operation. After the inverter is powered off and restarted, the data written last time will not saved.

If the data written by communication has to be effective after the inverter is powered off and restarted, the data should be written and saved in EEPROM. Function 10 can be used to write the parameters of MODBUS address to be saved into 0x00F.

By writing the MODBUS address corresponding to the parameters to be saved into 0x00FFH, the parameter data in RAM will be written and saved in EEPROM. As the maximum writing times of EEPROM is 100, 000, the input command had better not be used frequently. The command is similar to ENTER in the keypad, by pressing which the set parameters will be written into EEPROM. The record code 00FFH is special for writing. When the record is read, record code errors may happen (abnormality code 02H).

● Monitoring Content (Read-only)

MODBUS Address	Name	bit	Content
0020H	State Signal	0	Operation 1: Operation 0: Stop
		1	Reverse 1: Reverse 0: Forward
		2	Fault Resetting 1: Fault Resetting 0: No Fault Resetting
		3	Fault 1: Fault
		4	Alarm 1: Alarm
		5	Multi-functional Output Command 1 (1: DO ON 0: OFF)
		6	(Reserved)
		7	(Reserved)
		8	Multi-functional Output Command 4 (1: TA ON 0: OFF)
		9~F	(Reserved)
0021H	Fault Content	0	Overcurrent (OC)
		1	Accelerating Overvoltage (Ou1)
		2	Inverter Overload (OL2)
		3	Inverter Overheat (OH1)
		4	Decelerating Overvoltage (Ou2)
		5	Constant-speed Overvoltage (Ou3)
		6	Hall Current Detection Fault (HE)
		7	External Abnormality (EFO~EF1)
		8	Hardware Abnormality (CCF3~CCF6)
		9	Motor Overload (OL1)
		A	Input/ Output Phase Loss or Imbalance (SP1~SP2)
		B	Busbar Under-voltage (Uu1)
		C	Control Circuit Under-voltage (Uu2)
		D	Charging Circuit Under-voltage (Uu3)
		E	Grounding GF or Load Short Circuit (SC)
F	(Reserved)		
0022H	Alarm Content	0	Busbar Under-voltage Alarm(Uu)
		1	Inverter Overload Pre-alarm (OLP2)
		2	Analog Signal 1 Abnormality (AE1)
		3	Reserved
		4	Temperature too high (OH2)
		5	The serial communication doesn't receive the normal control signal (CE)
		6	The function code setting is inappropriate SF1
		7	The operation mode is inconsistent with the terminal setting SF2
		8	(Reserved)
		9	Motor Parameters Tuning Abnormality
A~F	(Reserved)		

MODBUS Address	Name	bit	Content
0023H	Before the frequency command compensation		
0024H	After the frequency command compensation		
0025H	AI1 Analog Input (V), 0~10.00V corresponding to 0~1000		
0026H	AI2 Analog Input (V), 0~10.00V corresponding to 0~1000 (S2R4GB and S2R75 are reserved)		
0027H	Output Current (A)		
0028H	Output Voltage (V)		
0029H	Set Frequency Hz		
002AH	(Reserved)		
002BH	Multi-functional Input Terminal State	0	Terminal X1 1: Close 0: Open
		1	Terminal X2 1: Close 0: Open
		2	Terminal X3 1: Close 0: Open
		3	Terminal X4 1: Close 0: Open
		4	Terminal X5 1: Close 0: Open
		5	Terminal X6 1: Close 0: Open
		6~F	(Reserved)
002CH	(Reserved)		
002DH	Multi-functional Output Terminal State	0	DO 1: "ON" 0: "OFF"
		1	(Reserved)
		2	TA-TB-TC Relay 1: "ON" 0: "OFF"
		3~F	(Reserved)
002EH	AO1 Analog Output (V) 0~10.00V corresponding to 0~1000		
002FH	(Reserved)		
0030H	(Reserved)		
0031H	DC Main Bus Voltage		
0032H	Output Torque		
0033H	Current Rotating Speed		
0034H	Set Rotating Speed		
0035H	Operating Linear Speed		
0036H	Set Linear Speed		
0037H	Output Power		
0038H	PID Feedback Quantity (%)		
0039H	PID Input Quantity (%)		
003AH	(Reserved)		
003BH	(Reserved)		
003CH	External Count Value		
003D~003FH	(Reserved)		

Appendix 3 Use of MODBUS Communication

MODBUS Address	Name	bit	Content
0040~004AH	Terminal State, 0040H~004AH corresponding to BIT0~BITA bit of 002BH in order		
004B~00FEH	(Reserved)		

● List of Modbus Register Addresses:

Function Code Form Parameter Code(DEC)	Modbus Register Address(HEX)
(Saving Confirmed)	(00FFH)
(Command Data)	(0001H~001FH)
(Monitoring Content)	(0020H~004FH)
P0.00~P0.19	0100H~ 0113H*
P1.00~P1.23	0200H~ 0217H
P2.00~P2.55	0300H~ 0337H
P3.00~P3.36	0400H~ 0424H
P4.00~P4.35	0500H~ 0523H
P5.00~P5.36	0600H~ 0624H
P6.00~P6.18	0700H~ 0712H
P7.00~P7.33	0800H~ 0821H
P8.00~P8.28	0900H~ 091CH
P9.00~P9.21	0A00H~ 0A15H
PA00~PA.30	0B00H~ 0B1EH
Pb.00~Pb.08	0C00H~ 0C08H
PC.00~PC.23	0D00H~ 0D17H
Pd.00~Pd.35	0E00H~ 0E23H
PE.00~PE.15	0F00H~ 0F0FH
PF.00~PF.12	1000H~ 100CH
(For parameter extending)	(1100H~FFFFH)

● Modbus Address Encoding Method:

Refer to the function codes in the function code table. High 8 bit HI= function group number + 1; low 8 bit LO= function code. Other register addresses not listed are reserved.

● List of Abnormality Codes

Abnormality Code	Content
01H	Command code error Command codes other than 03H, 08H and 10H
02H	Register address error None of the register addresses is registered Read the ENTER-confirmed special register[0X00FFH] The communication function of the address is not initiated in the function code setting. (Note1)
03H	Number error Number of data read or written is not between 1 and 16 In the writing manner, the command data is not the bit number *2
21H	Data setting error Upper and lower limit error during the control data & parameters input
22H	Writing manner error Write the non-revisable parameters or read-only parameters in operation (Note 2) Parameters write-protected (Note 3) Write data into the special read register Write in the case of CCF3, i.e. EEPROM fault
23H	Write in the case of under-voltage Write parameters in the case of Uu
24H	Write parameters from communication during the parameter processing At the time of fault resetting, system power supply cutoff or data saving
25H	CRC check fault (Note 4)

Note 1: Set the P0.03 and P0.04 frequency setting as serial communication (when writing address 0002) or set P0.07 operation command control manner as serial communication (when writing address 0001).

Note 2: For parameters that can be set in operation, please refer to the function parameter list. If a parameter that cannot be revised in operation but can be revised at the time of stop, please stop the inverter and then revise it.

Note 3: When parameters are write-protected and PF.01 is set as 1 or 2, please revise it as 0. Then all parameters can be revised.

Note 4: In case of CRC 16 check fault, response will be given even if the system receiving is over, and 25H fault will be reported to facilitate customer debugging.

Appendix 4 Keypad and tray(trepanning) Installation Dimension

4.1 Keypad

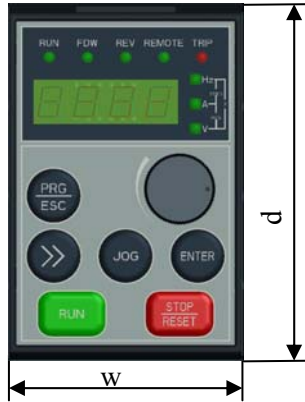

Fig. A4-1 Keypad Dimension

Table A4-1 Keypad Installation Dimension (Unit: mm)

Specifications	w	d
S2R4GB~S22R2GB, 3R75GB/31R5PB~3004GB/35R5PB	49±0.2	76.5±0.2
35R5GB/37R5PB and above	61±0.2	96.5±0.2

4.2 Keypad's tray

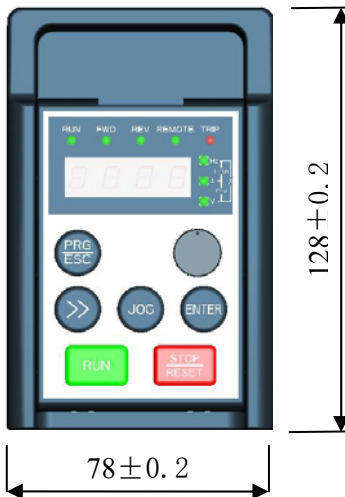

Fig. A4-2 Keypad's tray Installation Dimension (Unit: mm)

Appendix 5 Inverter Warranty Card

Inverter Warranty Card

Name of User:	
Address of User:	
Contact Person:	Tel.:
P.C.:	Fax:
Type:	Serial No.:
Date of Purchase:	Date of Fault:

Fault Details

Motor: ____KW ____Pole	Application of Motor: ____
Fault Occurrence Time: power supply, no-load, load __% Others: ____	
Fault Phenomena:	
Fault Display: OC OL OU OH LU None Others:	
Control Terminal Used:	
Operation after Resetting: Yes No	Output Voltage: Yes No
Total Working Time: ____Hrs	Fault Frequency: ____Hz

Installation Site Details

Power Voltage: U-V: ____ V, V-W: ____ V, W-U: ____ V	
Transformer Capacity: KVA	Inverter Earthing: Yes No
Distance from the Power Source: __m	Distance from the Motor: __m
Vibration: No, Medium, Strong	Dust: No, Medium, Much
Others:	